

Krzesta konferencyjne



profim

KONFERENCYJNE



Acos	4-5	
Ariz	6-9	
Bit	10-13	
Kala	14-17	
Komo	18-21	
MyTurn	22-23	
Sun	24-25	
Xenon	26-27	
Xenon Net	26-27	

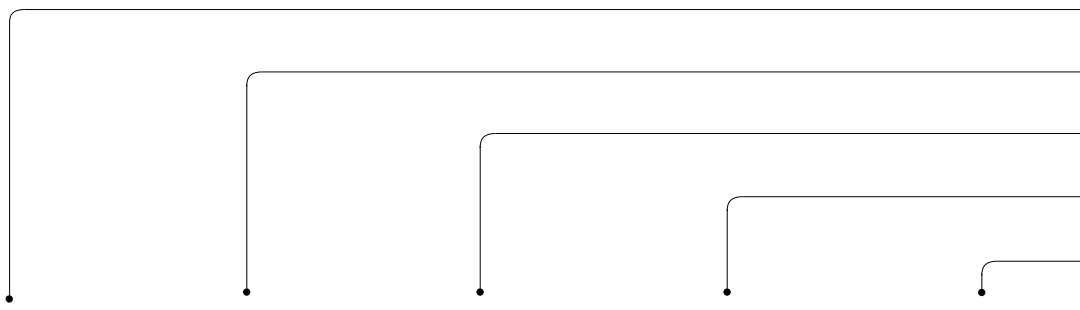

Sztaplowanie (tylko model V).
Stacking (only V models).



2



ACOS 10VN SATYNA O



ACOS 10VN SATYNA O



ACOS 10VN SATYNA O



ACOS 20VN CHROM O



ACOS 20VN CHROM O



ACOS 20VN CHROM O

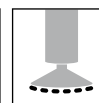
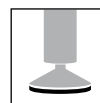



Ariz



ARIZ 570V chrom z blatem (B) i z koszem na gazety (K).
ARIZ 570V chrome with table top (B) and basket for newspapers (K).

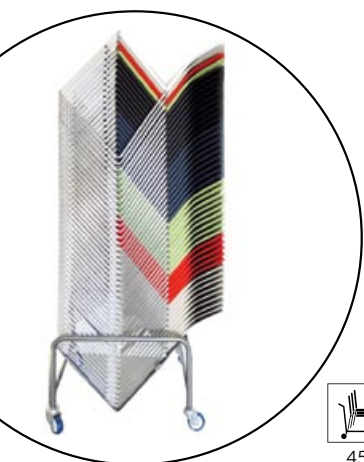

ARIZ 550CV SATYNA



ARIZ 550CV SATYNA

Dostępny wózek do transportu krzesel, umożliwiający
sztaplowanie nawet 45 sztuk krzesel.
Trolley for transporting the chairs enabling
stacking up to 45 chairs.





Opcja z blatem (B)
 - z lewej lub z prawej strony, występuje tylko
 w wersji krzesel bez podłokietników.
 Table top as an option
 table top (B) - left - or right sided,
 only with versions without armrests.



Łączenie krzesel z podłokietnikami.
 Joining for chairs with armrests.

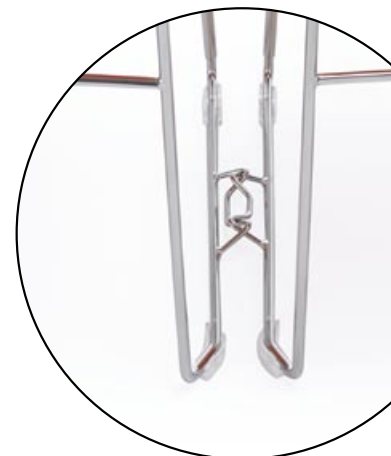

ARIZ 570V CZARNY



Łączenie krzesel bez podłokietników.
 Joining for chairs without armrests.



Krzesła ARIZ dostępne są w 7 kolorach plastików:
 ARIZ chairs are available in 7 colours of plastics:





ARIZ 555V CHROM



ARIZ 575V CZARNY



ARIZ 575V CHROM



ARIZ 555V CHROM

Ramka oparcia siatkowego w modelach 555 i 575 - tylko w kolorach: czarny, biały, popiel.

Dostępne wersje z siatkowym oparciem:

1. plastik siedziska czarny + ramka czarna + siatka czarna
2. plastik siedziska biały + ramka biała + siatka czarno - biała
3. plastik siedziska popielaty + ramka popielata + siatka czarno - popielata

The frame of mesh backrest in models 555 and 575 - only in colours: black, white, grey.

Available options with mesh backrest:

1. seat plastic black + backrest frame black + mesh fabric black
2. seat plastic white + backrest frame white + mesh fabric black and white
3. seat plastic grey + backrest frame grey + mesh fabric black and grey

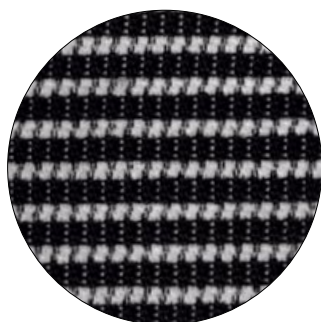

GZ - 26

Siatka czarno - biała.
Mesh fabric black and white.

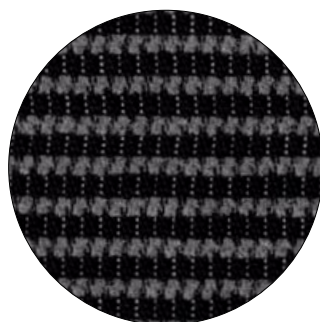

GZ - 20

Siatka czarno - popielata.
Mesh fabric black and grey.

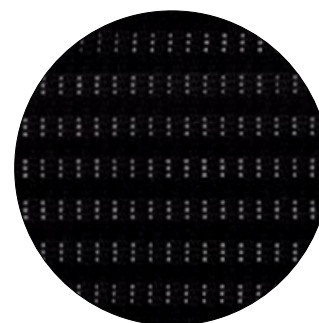

GZ - 21

Siatka czarna.
Mesh fabric black.



Krzeseł ARIZ z oparciem z siatki dostępne są w 3 kolorach plastików.
ARIZ chairs with mesh fabric backrest are available in 3 colours of plastics.





ARIZ 555V SATYNA 2P



ARIZ 560V CHROM 2P



ARIZ 550V CHROM 2P



ARIZ 550V CHROM 2P



ARIZ 575V CZARNY 2P



Bit



BIT 575H CHROM 2P



BIT 575H CHROM 2P



BIT 560H CZARNY 2P



BIT 550H METALIK



BIT 570H CHROM



BIT 560H CHROM 2P



5

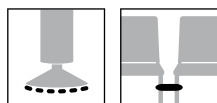



BIT 570V CHROM 2P



BIT 550V CHROM



BIT 570V METALIK 2P



3



BIT 560V CZARNY 2P



BIT 575V CHROM 2P

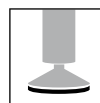
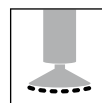
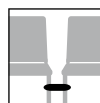

Bit



BIT 550V CHROM

Kala



KALA 570H CHROM PP



KALA 570H SATYNA PP



KALA 670H CHROM PP



KALA 670H WOOD METALIK

krótkie oparcie
short backrest

długie oparcie
long backrest

Kala



KALA 570V METALIK



KALA 570V CHROM

krótkie oparcie
short backrest



KALA 670V METALIK

długie oparcie
long backrest



KALA 670V METALIK PP

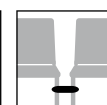
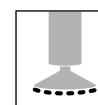

Kala



KALA 570L2B METALIK



KALA 570L3 METALIK



KALA 570L2B METALIK

Komo



KOMO V CHROM



KOMO V CHROM 2P



KOMO V CHROM



KOMO V CHROM



KOMO V CHROM 2P

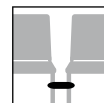
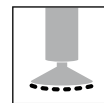

Komo



KOMO VN SATYNA 2P

Komo



KOMO H CHROM 2P

Komo



KOMO H CHROM 2P



KOMO H CHROM 2P



KOMO H METALIK



KOMO H METALIK



KOMO H METALIK 2P



3

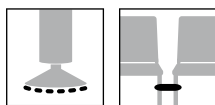

MyTurn



MYTURN 21VN CHROM O



MYTURN 21VN CHROM O

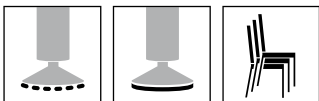



MyTurn

Nakładka na podłokietnik tapicerowana zawsze czarną skórą.
 Armrest pad upholstered always in black leather.

Sun



SUN H CHROM 2P



SUN H CZARNY 2PB



SUN H CZARNY 2PB

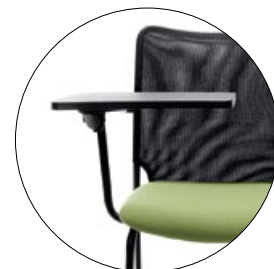

Opcja z blatem.
 Table top as an option.



5



SUN V CHROM 2P



SUN V CHROM 2P

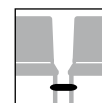
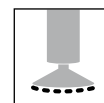



Sun



SUN H SATYNA 2P



Xenon

Xenon Net



4



XENON 20H CHROM 2P



XENON 20V CHROM 2P

Xenon
Xenon Net



XENON NET 20H CHROM 2P



XENON NET 20V CHROM 2P



4

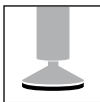
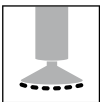
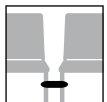

Acos str. 4-5

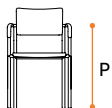
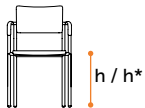
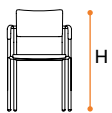

W

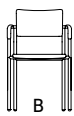
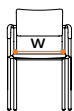
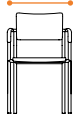

D

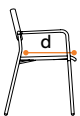

max

*Wysokość siedziska
zmierzona zgodnie
z normą PN EN 13761

*Seat height measured
according to PN EN 13761
norm.

Ariz str. 6-9



10V / 10VN

H 1010 / h 490 / h* 410 / P 680
W 580 / w 510 / O 500 / B 580
D 650 / d 450

* dotyczy tylko wersji V
only in versions V



*2



20V / 20VN

H 920 / h 490 / h* 410 / P 680
W 580 / w 510 / O 500 / B 580
D 650 / d 450

* dotyczy tylko wersji V
only in versions V



*2



550V

H 850 / h 470 / h* 430
W 580 / w 450 / O 470 / B 580
D 530 / d 420



15

Ariz str. 6-9



570V

H 860 / h 480 / h* 440
W 580 / w 460 / O 500 / B 580
D 530 / d 420



5



570V 2P

H 860 / h 480 / h* 440 / P 660
W 610 / w 460 / O 500 / B 580
D 530 / d 420



5



575V

H 850 / h 480 / h* 440
W 580 / w 460 / O 470 / B 580
D 530 / d 420



5



575V 2P

H 850 / h 480 / h* 440 / P 660
W 610 / w 460 / O 470 / B 580
D 530 / d 420



5

Bit str. 10-13



550H / 550H 2P

H 790 / h 450 / h* 440 / P 680
W 560 / w 470 / O 470 / B 470
D 540 / d 430



5



555H / 555H 2P

H 820 / h 450 / h* 440 / P 680
W 560 / w 470 / O 470 / B 470
D 570 / d 450



5



550V / 550V 2P

H 820 / h 460 / h* 440 / P 690
W 550 / w 470 / O 470 / B 500
D 520 / d 430



3



555V / 555V 2P

H 850 / h 460 / h* 440 / P 690
W 550 / w 470 / O 470 / B 500
D 550 / d 450



3

Bit str. 10-13



575H / 575H 2P

H 820 / h 480 / h* 460 / P 680
W 560 / w 480 / O 470 / B 470
D 570 / d 440



5



570V / 570V 2P

H 820 / h 490 / h* 460 / P 690
W 550 / w 480 / O 470 / B 500
D 520 / d 420



3



575V / 575V 2P

H 850 / h 490 / h* 460 / P 690
W 550 / w 480 / O 470 / B 500
D 550 / d 440



3



10

550V 2P

H 850 / h 470 / h* 430 / P 660
W 610 / w 450 / O 470 / B 580
D 530 / d 420



15

555V

H 850 / h 470 / h* 430
W 580 / w 450 / O 470 / B 580
D 530 / d 410



10

555V 2P

H 850 / h 470 / h* 430 / P 660
W 610 / w 450 / O 470 / B 580
D 530 / d 410



5

560V

H 850 / h 480 / h* 440
W 580 / w 460 / O 470 / B 580
D 530 / d 430



5

560V 2P

H 850 / h 480 / h* 440 / P 660
W 610 / w 460 / O 470 / B 580
D 530 / d 430



2

550CV

H 1100 / h 720 / h* 680
W 580 / w 450 / O 470 / B 580
D 540 / d 420



2

555CV

H 1100 / h 720 / h* 680
W 580 / w 450 / O 470 / B 580
D 540 / d 410



2

560CV

H 1100 / h 730 / h* 690
W 580 / w 460 / O 470 / B 580
D 540 / d 430



2

570CV / 575CV

H 1110 / h 730 / h* 690
W 580 / w 460 / O 500 / B 580
D 540 / d 420



5

560H / 560H 2P

H 790 / h 480 / h* 460 / P 680
W 560 / w 480 / O 470 / B 470
D 540 / d 450



3

560V / 560V 2P

H 820 / h 490 / h* 460 / P 690
W 550 / w 480 / O 470 / B 500
D 520 / d 450



5

570H / 570H 2P

H 790 / h 480 / h* 460 / P 680
W 560 / w 480 / O 470 / B 470
D 540 / d 420

Wymiary mają charakter orientacyjny i mogą się różnić w zależności od wybranej konfiguracji produktu. Metoda pomiaru produktów dostępna do pobrania pod linkiem: www.profim.pl/Metoda_pomiaru_produkutow.pdf

The measurements are approximate and can differ depending on the product configuration. Measuring methodology is available at this link: www.profim.eu/Measuring_methodology.pdf

Kala

str. 14-17



2

670H / 670H PP

H 860 / h 460 / h* 430 / P 700
W 550 / w 460 / O 440 / B 530
D 560 / d 440



670V / 670V PP

H 860 / h 460 / h* 430 / P 700
W 550 / w 460 / O 440 / B 540
D 570 / d 440



2

570H / 570H PP

H 830 / h 460 / h* 430 / P 700
W 550 / w 460 / O 440 / B 530
D 530 / d 440



570V / 570V PP

H 830 / h 460 / h* 430 / P 700
W 550 / w 460 / O 440 / B 540
D 530 / d 440

Kala str. 14-17

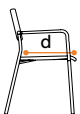
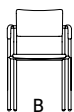
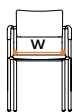
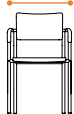
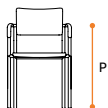
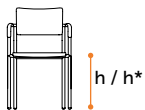
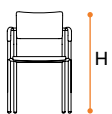

max



570L2 / 570L1B / 670L2 / 670L1B

H 800 / h 430 / h* 400
W 1230 / w 460 / O 440 / B 1230
D 580 / d 440



570L3 / 570L2B / 670L3 / 670L2B

H 800 / h 430 / h* 400
W 1850 / w 460 / O 440 / B 1850
D 580 / d 440



570L4 / 570L3B / 670L4 / 670L3B

H 800 / h 430 / h* 400
W 2470 / w 460 / O 440 / B 2470
D 580 / d 440

Komo str. 18-21



4

H

H 820 / h 480 / h* 450
W 490 / w 450 / O 440 / B 480
D 580 / d 480



3

H 2P

H 820 / h 480 / h* 450 / P 670
W 530 / w 450 / O 440 / B 480
D 580 / d 480



*4

V / VN

H 810 / h 470 / h* 440
W 510 / w 450 / O 440 / B 510
D 580 / d 460

* dotyczy tylko wersji V
only in versions V



*3

V 2P / VN 2P

H 810 / h 470 / h* 440 / P 670
W 550 / w 450 / O 440 / B 510
D 580 / d 460

* dotyczy tylko wersji V 2P
only in versions V 2P

Sun str. 24-25



5

H

H 880 / h 500 / h* 460
W 500 / w 430 / O 440 / B 500
D 580 / d 430



5

H 2P

H 880 / h 500 / h* 460 / P 720
W 550 / w 430 / O 440 / B 500
D 580 / d 430



5

V 2P

H 860 / h 470 / h* 430 / P 690
W 550 / w 490 / O 460 / B 540
D 580 / d 440

Xenon Net str. 26-27



4

H

H 840 / h 480 / h* 450
W 540 / w 460 / O 430 / B 540
D 570 / d 440



4

H 2P

H 840 / h 480 / h* 450
W 590 / w 460 / O 430 / B 560
D 570 / d 440 / P 670



*4

V/VN

H 860 / h 480 / h* 440
W 550 / w 460 / O 430 / B 550
D 580 / d 440

* dotyczy tylko wersji V
only in versions V



*4

V 2P / VN 2P

H 860 / h 480 / h* 440
W 590 / w 460 / O 430 / B 570
D 580 / d 440 / P 680

* dotyczy tylko wersji V 2P
only in versions V 2P

*Wysokość siedziska
zmierzona zgodnie
z normą PN EN 13761

*Seat height measured
according to PN EN 13761
norm.



570L5 / 570L4B / 670L5 / 670L4B

H 800 / h 430 / h* 400
W 3090 / w 460 / O 440 / B 3090
D 580 / d 440

MyTurn str. 22-23



*2

V / VN

H 940 / h 480 / h* 410
W 610 / w 530 / O 500 / B 580
D 600 / d 460 / P 680

* dotyczy tylko wersji V
only in versions V

Xenon str. 26-27



4

H

H 840 / h 480 / h* 450
W 540 / w 460 / O 430 / B 540
D 570 / d 440



4

H 2P

H 840 / h 480 / h* 450
W 590 / w 460 / O 430 / B 560
D 570 / d 440 / P 670



*4

V / VN

H 860 / h 480 / h* 440
W 550 / w 460 / O 430 / B 550
D 580 / d 440

* dotyczy tylko wersji V
only in versions V



*4

V 2P / VN 2P

H 860 / h 480 / h* 440
W 590 / w 460 / O 430 / B 570
D 580 / d 440 / P 680

* dotyczy tylko wersji V 2P
only in versions V 2P

Wymiary mają charakter orientacyjny i mogą się różnić w zależności od wybranej konfiguracji produktu.
Metoda pomiaru produktów dostępna do pobrania pod linkiem:
www.profim.pl/Metoda_pomiaru_produkow.pdf

The measurements are approximate and can differ depending on the product configuration.
Measuring methodology is available at this link:
www.profim.eu/Measuring_methodology.pdf

PRZY ZAMÓWIENIU PROSIMY STOSOWAĆ SYMBOLE WEDŁUG KODU:
PLEASE USE CODES AT ORDER

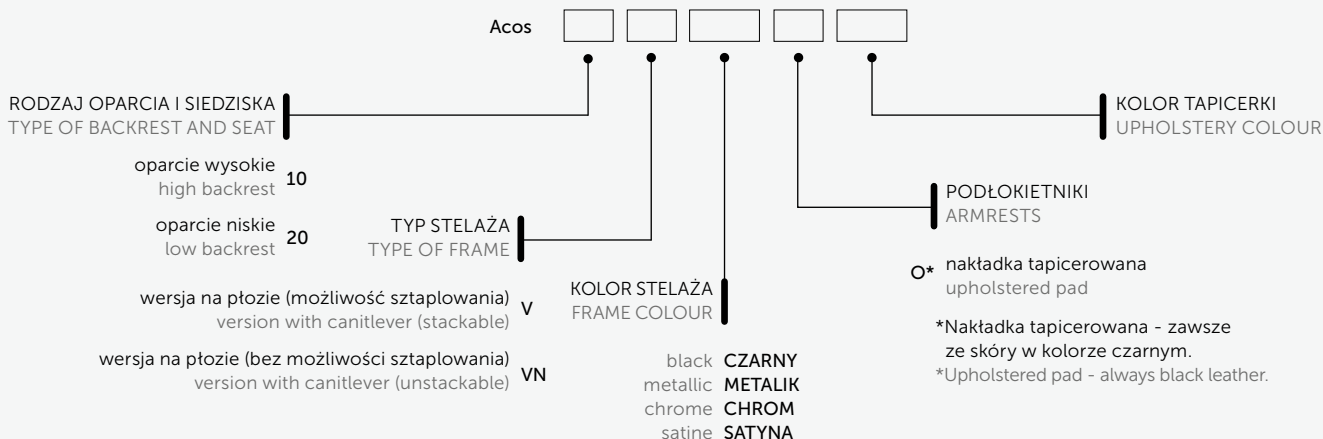

Acos

PRZY ZAMÓWIENIU PROSIMY STOSOWAĆ SYMBOLE WEDŁUG KODU:
PLEASE USE CODES AT ORDER

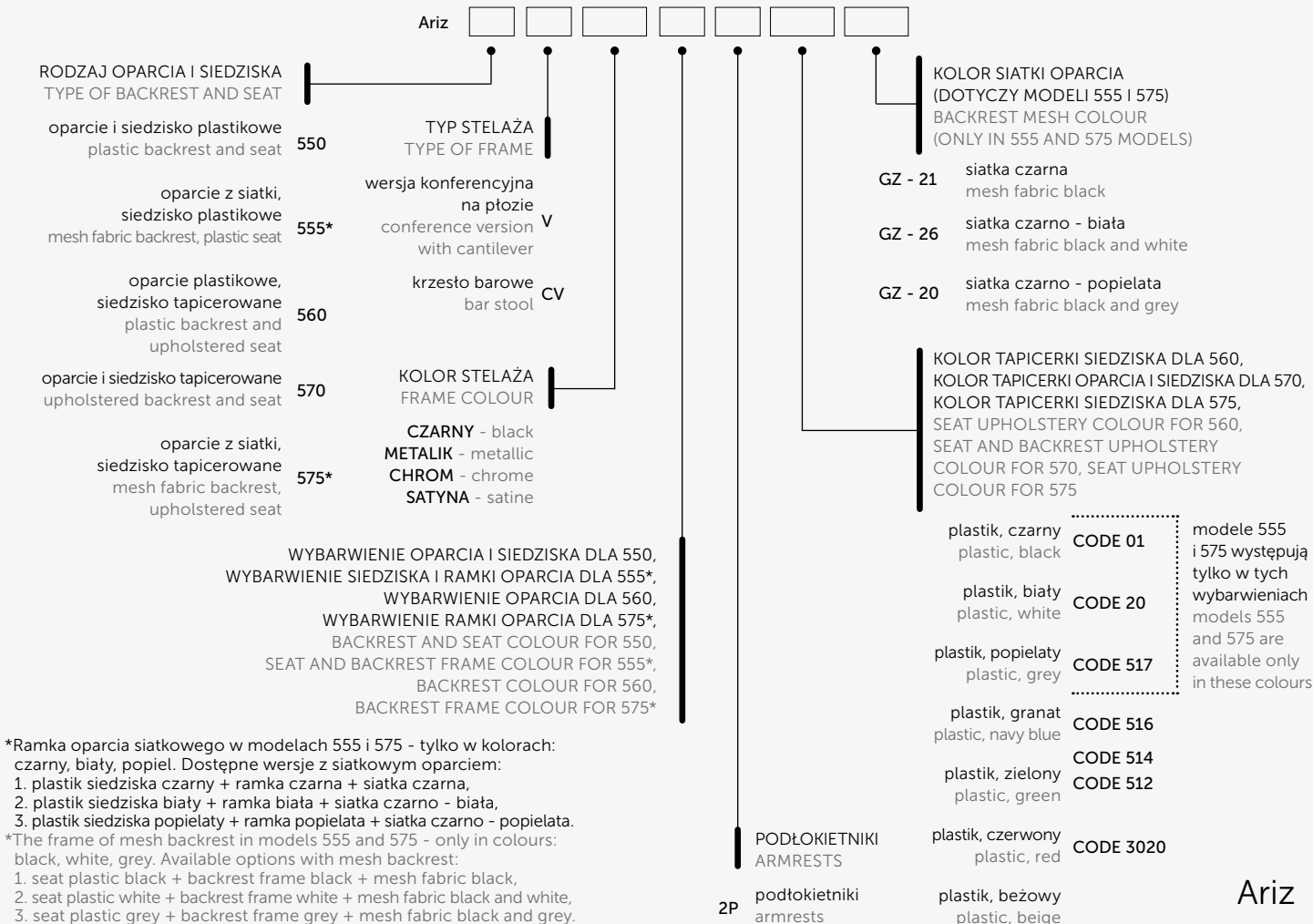

Ariz

PRZY ZAMÓWIENIU PROSIMY STOSOWAĆ SYMBOLE WEDŁUG KODU:
PLEASE USE CODES AT ORDER

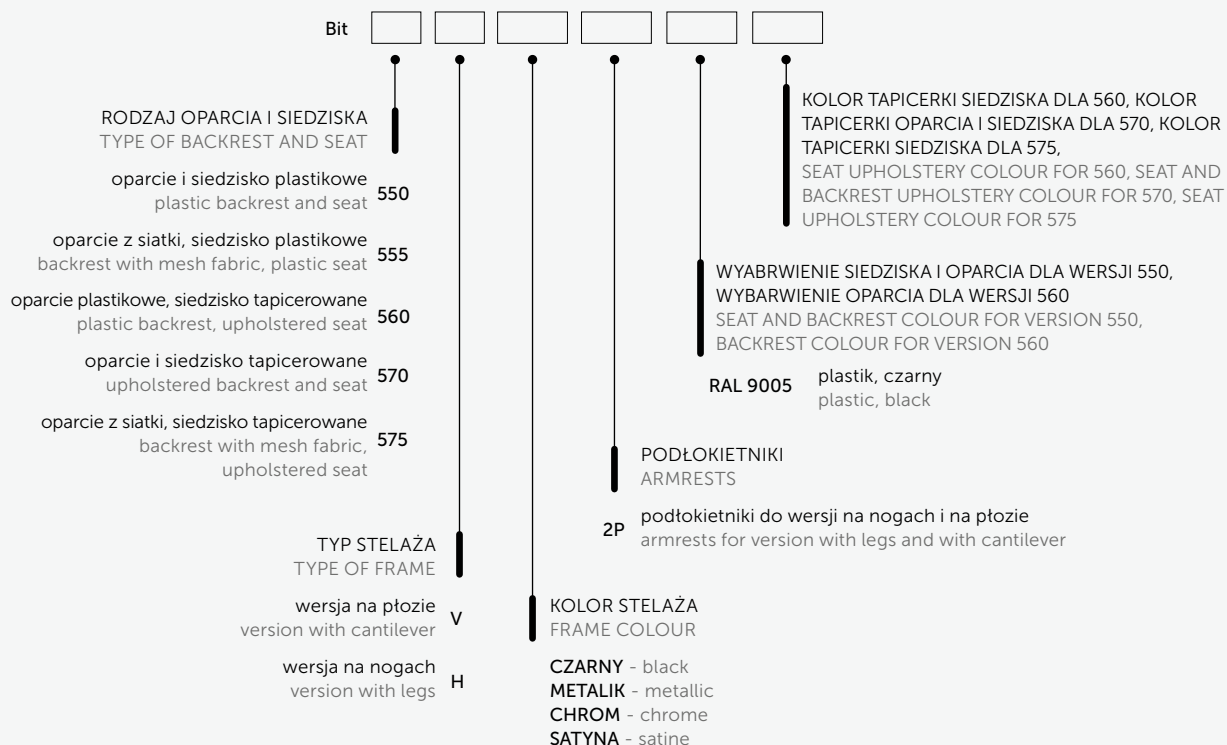

Bit

PRZY ZAMÓWIENIU PROSIMY STOSOWAĆ SYMBOLE WEDŁUG KODU:
PLEASE USE CODES AT ORDER

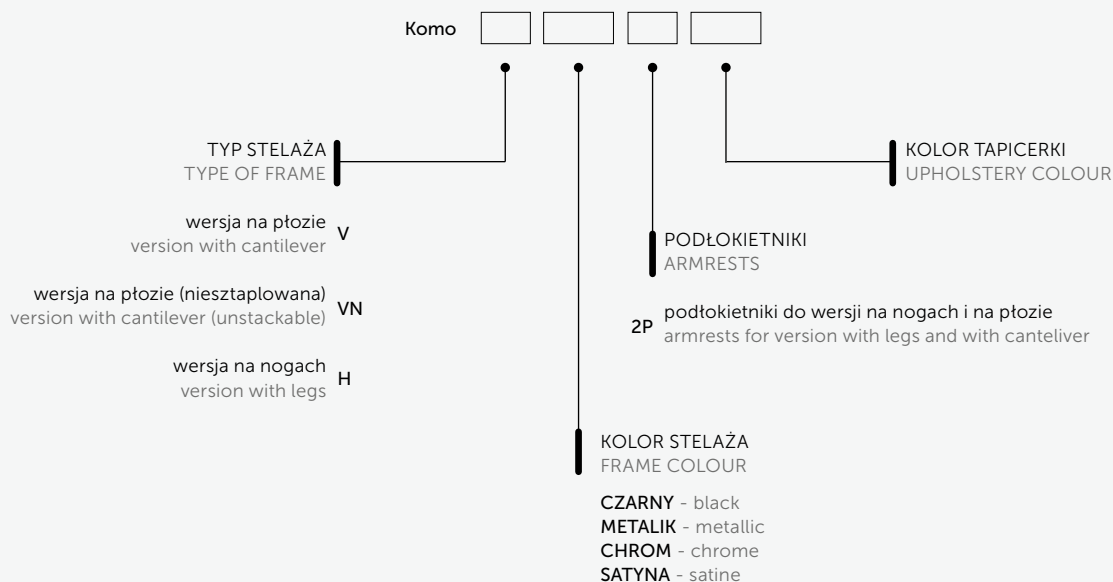

Komo

PRZY ZAMÓWIENIU PROSIMY STOSOWAĆ SYMBOLE WEDŁUG KODU:
PLEASE USE CODES AT ORDER

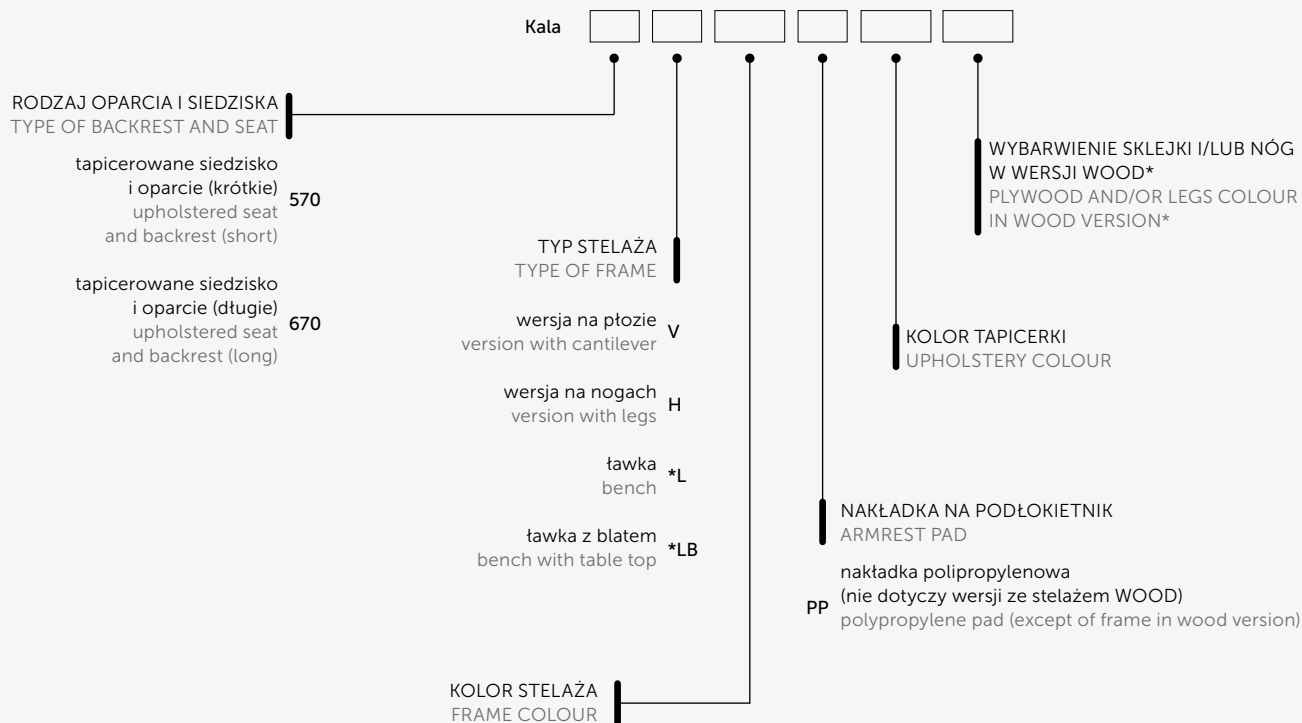

stelaż czarny z drewnianym przodem
(tylko w wersji na nogach)
black frame with wooden front
(only in version with legs) **WOOD CZARNY**

stelaż metalik z drewnianym przodem
(tylko w wersji na nogach)
metallic frame with wooden front
(only in version with legs) **WOOD METALIK**

stelaż chrom z drewnianym przodem
(tylko w wersji na nogach)
chrome frame with wooden front
(only in version with legs) **WOOD CHROM**

stelaż satyna z drewnianym przodem
(tylko w wersji na nogach)
satine frame with wooden front
(only in version with legs) **WOOD SATYNA**

*przy zamówieniu prosimy podać ilość siedzisk (1-5)
*please indicate the number of seats at order (1-5)

ławka z dwoma siedziskami
bench with two seats **L2**

ławka z trzema siedziskami
bench with three seats **L3**

ławka z czterema siedziskami
bench with four seats **L4**

ławka z pięcioma siedziskami
bench with five seats **L5**

ławka z jednym siedziskiem i blatem
bench with one seat and table top **L1B**

ławka z dwoma siedziskami i blatem
bench with two seats and table top **L2B**

ławka z trzema siedziskami i blatem
bench with three seats and table top **L3B**

ławka z czterema siedziskami i blatem
bench with four seats and table top **L4B**

*Wybarwienia stelaża drewnianego - wg standardowych kolorów
(H5, H6, H7, H8, H11, H12).

*Colours of wooden front legs - standard colours of lacquer
(H5, H6, H7, H8, H11, H12).

Kala

PRZY ZAMÓWIENIU PROSIMY STOSOWAĆ SYMBOLE WEDŁUG KODU:
PLEASE USE CODES AT ORDER

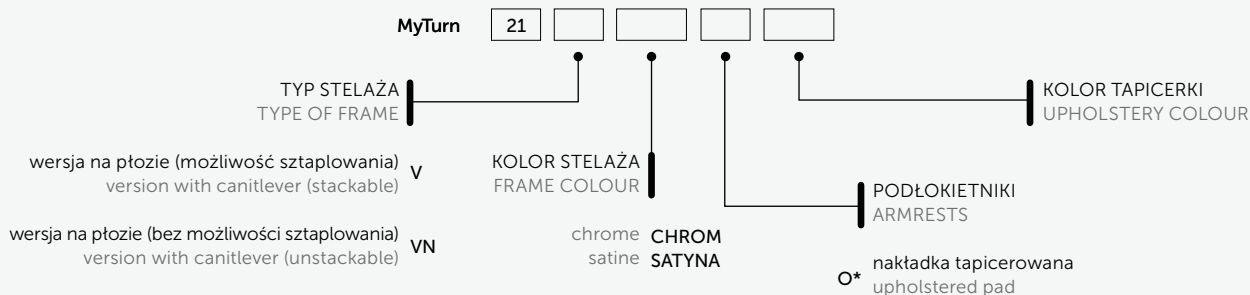

*Nakładka tapicerowana: modele tapicerowane skórą - nakładka ze skóry w kolorze tapicerki fotela, modele tapicerowane tkaniną, Eco, Softline - nakładka ze skóry zawsze w kolorze czarnym

*Upholstered armpad: models with leather upholstery - armpad upholstered with the same colour, models with fabric, Eco or Softline upholstery - black leather on the pad.

MyTurn

PRZY ZAMÓWIENIU PROSIMY STOSOWAĆ SYMBOLE WEDŁUG KODU:
PLEASE USE CODES AT ORDER

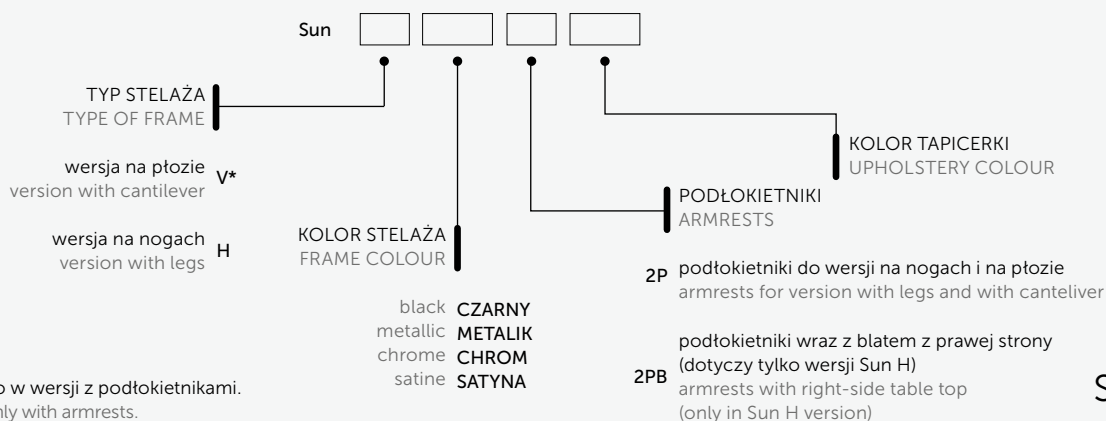

*Wersja SUN V występuje tylko w wersji z podłokietnikami.

*SUN V models are available only with armrests.

Sun

PRZY ZAMÓWIENIU PROSIMY STOSOWAĆ SYMBOLE WEDŁUG KODU:
PLEASE USE CODES AT ORDER

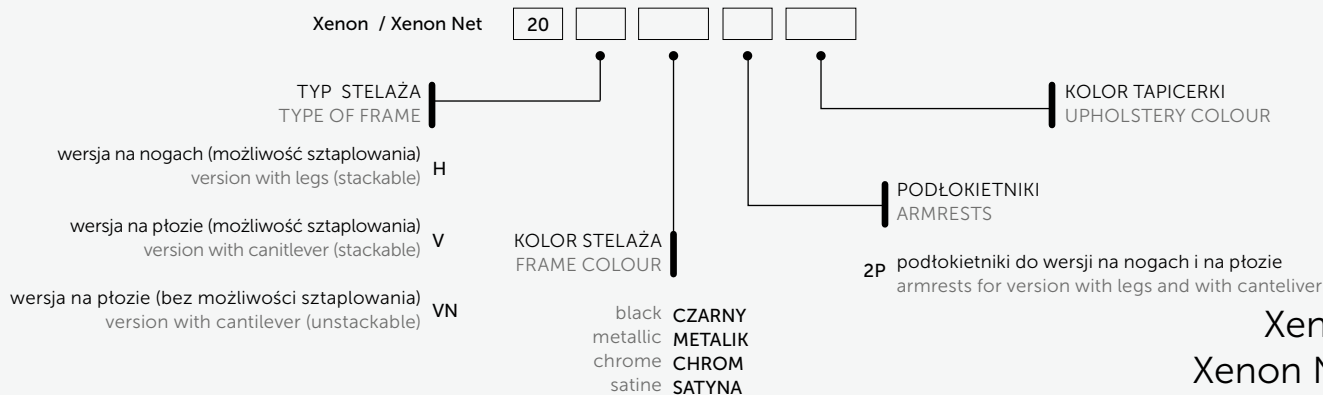

Xenon
Xenon Net

www.profim.pl

Producent zastrzega sobie prawo do zmian konstrukcyjnych i zmiany parametrów nie pogarszających walorów użytkowych produktów. Kolory reprodukowane w katalogu mogą odbiegać od rzeczywistych kolorów oferowanych mebli.

The producer reserves the right to conduct construction changes and improvements of the products.
Colours presented in the catalogue may vary from the original colours of furniture.



CHROM (III)
Technologia przyjazna
dla środowiska

CHROMIUM (III)
Eco-Friendly Technology

