

**OPIS TECHNICZNY**

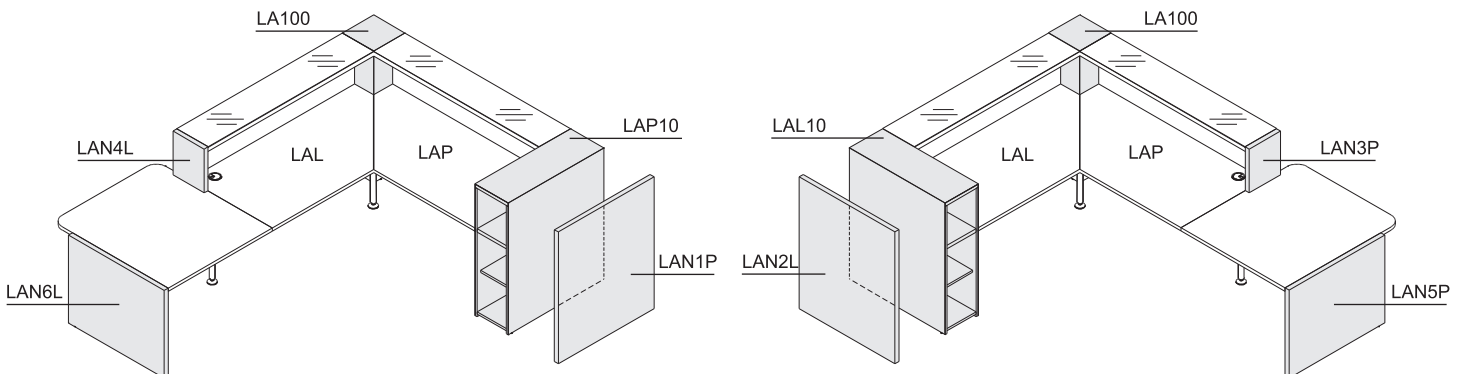
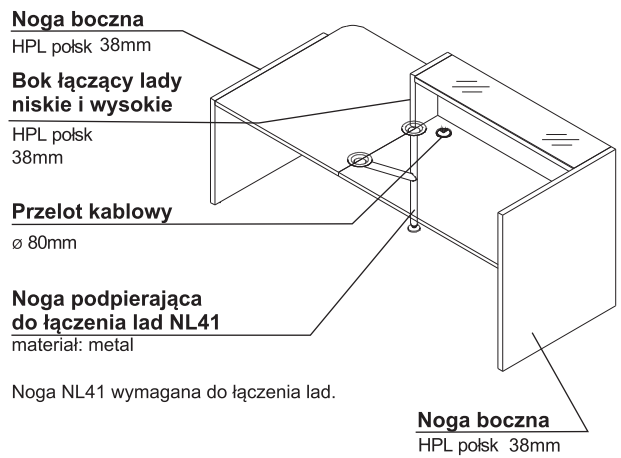
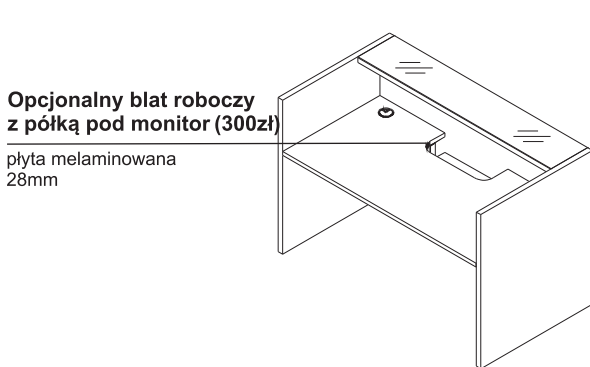
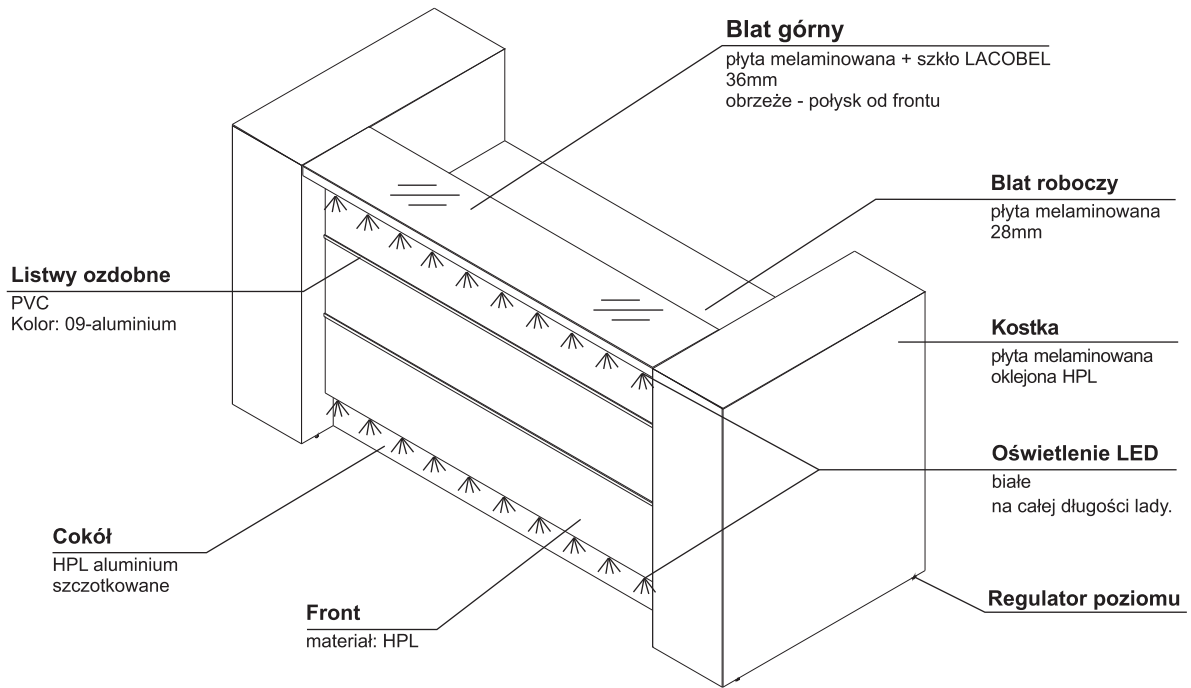
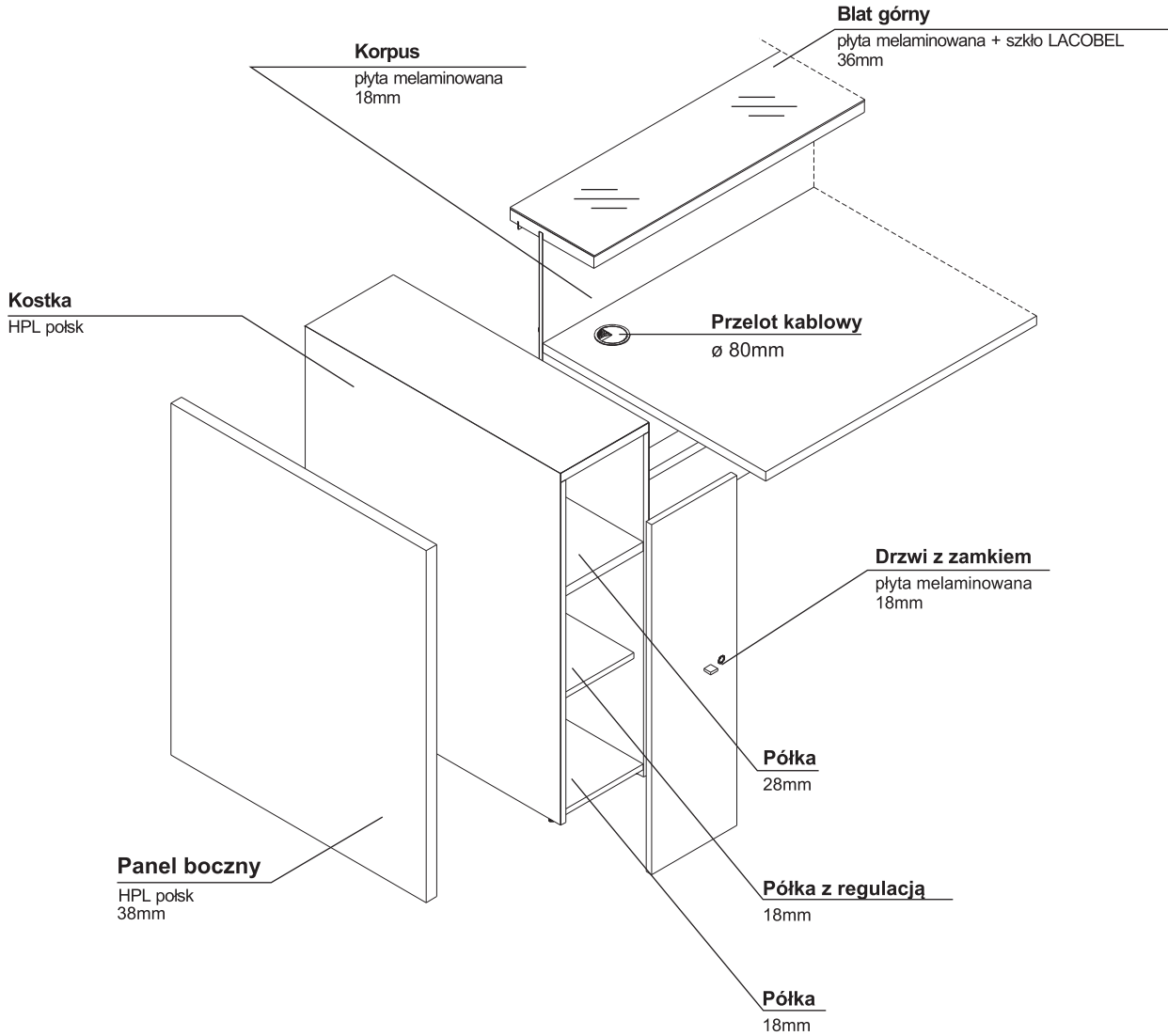
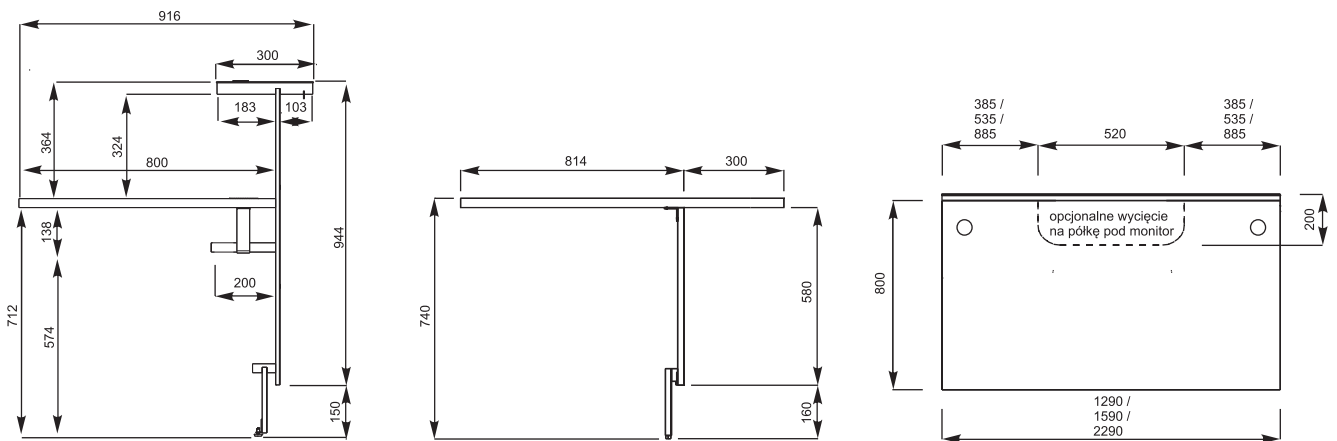
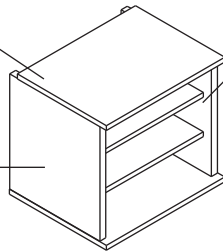

**OPIS TECHNICZNY**

**WYMIARY**

**REGAŁ/SZAFKA NA LADE RECEPCYJNĄ**
**Wieniec górny**

 płyta melaminowana  
 12mm

**Półka**

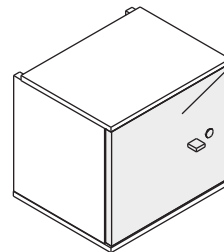

 płyta melaminowana  
 12mm

**Korpus**

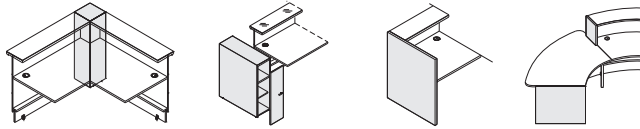
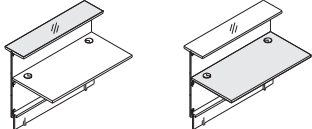
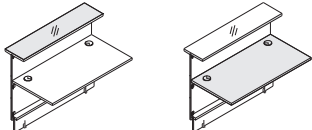
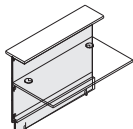
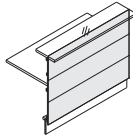
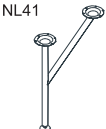

 płyta melaminowana  
 18mm

**Drzwi**

 płyta melaminowana  
 18mm

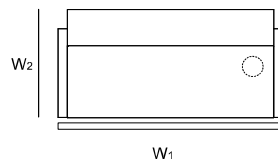
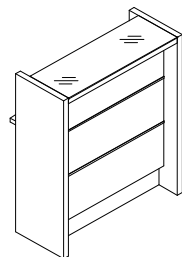
**KOLORYSTYKA**



73-BIAŁY POŁYSK	148-SZARY POŁYSK			
LACOBEL, BIAŁY	67-BIAŁY PASTEL			
LACOBEL, SREBRNY	26-ALUMINIUM SATINATO			
67-BIAŁY PASTEL				
31-DAB KANADYJSKI	34-KASZTAN	73-BIAŁY POŁYSK	74-POMARAŃCZOWY POŁYSK	
80-ZIEŁONY POŁYSK	81-BORDOWY POŁYSK	102-ZÓŁTY POŁYSK	127-RÓŻOWY POŁYSK	
15-BIAŁY	NL41			
26-ALUMINIUM SATINATO	67-BIAŁY PASTEL			

**UKŁADY LAD**

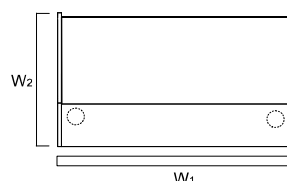
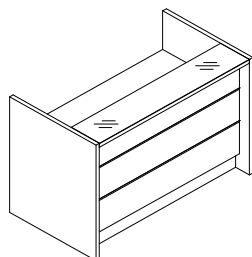
SYMBOL	WYMIARY [mm]					PLN				UWAGI
	W <sub>1</sub>	W <sub>2</sub>	D <sub>1</sub>	D <sub>2</sub>	H		kg	m <sup>3</sup>	szt	
LAV96L	920	454	-	-	1105		51.5	0.182	7	



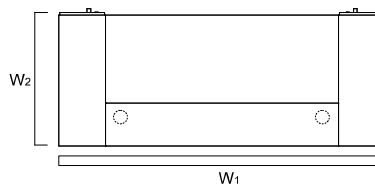
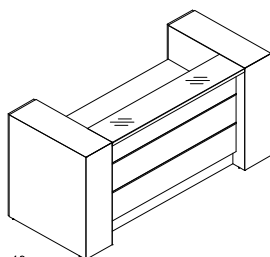

09  
13  
16  
LAN1P+LA23L+LAN2L

SYMBOL	WYMIARY [mm]					PLN				UWAGI
	W <sub>1</sub>	W <sub>2</sub>	D <sub>1</sub>	D <sub>2</sub>	H		kg	m <sup>3</sup>	szt	
LAV95L <sup>09</sup>	920	917	-	-	1105		88.0	0.252	6	
LAV75L <sup>13</sup>	1366	917	-	-	1105		127.6	0.369	8	
LAV76L <sup>16</sup>	1666	917	-	-	1105		145.5	0.424	8	
LAV77L <sup>23</sup>	2366	917	-	-	1105		182.0	0.584	9	



13  
16  
LAD10+LAP10+LA23L+LAL10+LAD10

SYMBOL	WYMIARY [mm]					PLN				UWAGI
	W <sub>1</sub>	W <sub>2</sub>	D <sub>1</sub>	D <sub>2</sub>	H		kg	m <sup>3</sup>	szt	
LAV01L <sup>13</sup>	1926	937	-	-	1105		185.6	1.031	10	
LAV02L <sup>16</sup>	2226	937	-	-	1105		203.5	1.087	10	
LAV03L <sup>23</sup>	2926	937	-	-	1105		240.0	1.246	11	

LEGENDA:

 - WAGA NETTO

 - OBJĘTOŚĆ

 - ILOŚĆ PACZEK

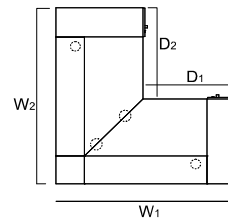
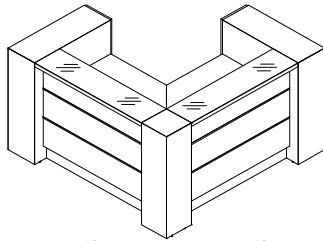
**UKŁADY LAD**

LAD10+LAP10+LAP23L+LA100+NL41+LAL23L+LAL10+LAD10

SYMBOL	WYMIARY [mm]					PLN				UWAGI
	W <sub>1</sub>	W <sub>2</sub>	D <sub>1</sub>	D <sub>2</sub>	H		kg	m <sup>3</sup>	szt	
13 <b>LAV10L</b> 13	1908	1908	991	991	1105		242.4	1.394	15	
13 <b>LAV11L</b> 16	1908	2208	991	1291	1105		262.3	1.452	17	
13 <b>LAV12L</b> 23	1908	2908	991	1991	1105		288.8	1.591	18	
16 <b>LAV13L</b> 13	2208	1908	1291	991	1105		262.3	1.452	17	
16 <b>LAV14L</b> 16	2208	2208	1291	1291	1105		270.2	1.488	15	
16 <b>LAV15L</b> 23	2208	2908	1291	1991	1105		302.7	1.638	18	
23 <b>LAV16L</b> 13	2908	1908	1991	991	1105		288.8	1.591	18	
23 <b>LAV17L</b> 16	2908	2208	1991	1291	1105		302.7	1.638	18	
23 <b>LAV18L</b> 23	2908	2908	1991	1991	1105		323.2	1.767	17	

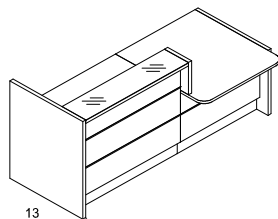
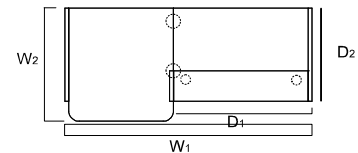
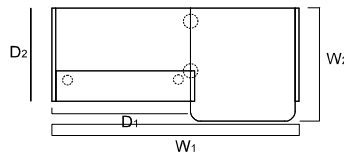
**A**
**B**

A: LAN1P+LA23L+NL41+LAN4L+LAU11L+LAN6L

B: LAN5P+LAU11L+NL41+LAN3P+LA23L+LAN2L

SYMBOL		WYMIARY [mm]					PLN				UWAGI
A	B	W <sub>1</sub>	W <sub>2</sub>	D <sub>1</sub>	D <sub>2</sub>	H		kg	m <sup>3</sup>	szt	
13 <b>LAV19L</b> 13	13 <b>LAV20L</b> 13	2366	1114	1328	917	1105		138.9	0.509	12	
16 <b>LAV21L</b> 16	16 <b>LAV22L</b> 16	2666	1114	1628	917	1105		152.3	0.556	12	
23 <b>LAV23L</b> 23	23 <b>LAV24L</b> 23	3366	1114	2318	917	1105		178.8	0.695	13	

LEGENDA:

- WAGA NETTO

- OBJĘTOŚĆ

- ILOŚĆ PACZEK

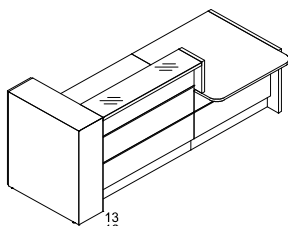
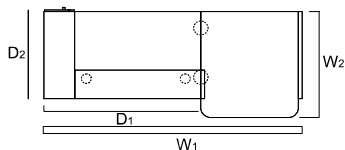
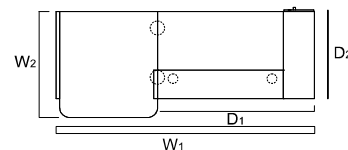
**UKŁADY LAD**

**A**

**B**

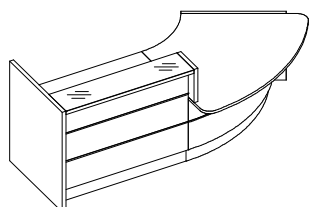
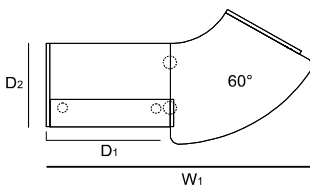
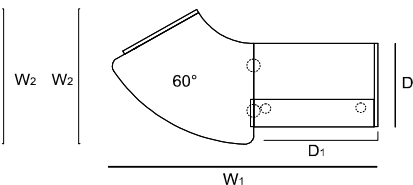
**A:** LAD10+LAP10+LA23L+NL41+LAN4L+LAU11L+LAN6L

**B:** LAN5P+LAU11L+NL41+LAN3P+LA23L+LAL10+LAD10

SYMBOL		WYMIARY [mm]					PLN	kg	m3	szt	UWAGI
A	B	W <sub>1</sub>	W <sub>2</sub>	D <sub>1</sub>	D <sub>2</sub>	H					
LAV41L <sup>13</sup>	LAV42L <sup>13</sup>	2646	1134	1608	937	1105	167.9	0.840	13		
LAV43L <sup>16</sup>	LAV44L <sup>16</sup>	2946	1134	1908	937	1105	171.8	0.875	13		
LAV45L <sup>23</sup>	LAV46L <sup>23</sup>	3646	1134	2608	937	1105	207.8	1.026	14		

**A**

**B**

**A:** LAN1P+LA23L+NL41+LAN4L+LAV66L+LAN6L

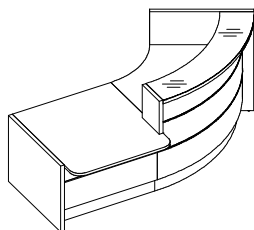
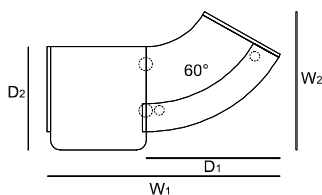
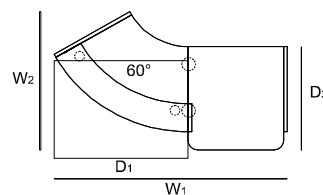
**B:** LAN5P+LAV66L+NL41+LAN3P+LA23L+LAN2L

SYMBOL		WYMIARY [mm]					PLN	kg	m3	szt	UWAGI
A	B	W <sub>1</sub>	W <sub>2</sub>	D <sub>1</sub>	D <sub>2</sub>	H					
LAV88L <sup>13</sup>	LAV89L <sup>13</sup>	2845	1111	1328	917	1105	160.9	0.832	12		
LAV91L <sup>16</sup>	LAV92L <sup>16</sup>	3145	1111	1628	917	1105	174.3	0.879	12		
LAV93L <sup>23</sup>	LAV94L <sup>23</sup>	3845	1111	2318	917	1105	200.8	1.018	13		

**A**

**B**

**A:** LAN5P+LAU11L+NL41+LAN3P+LAV64L+LAN2L

**B:** LAN1P+LAV64L+NL41+LAN4L+LAU11L+LAN6L

SYMBOL		WYMIARY [mm]					PLN	kg	m3	szt	UWAGI
A	B	W <sub>1</sub>	W <sub>2</sub>	D <sub>1</sub>	D <sub>2</sub>	H					
LAV84L	LAV85L	2443	1489	1404	1114	1105	149.8	0.957	12		

LEGENDA:

- WAGA NETTO

- OBJĘTOŚĆ

- ILOŚĆ PACZEK

**UKŁADY LAD**

A

B

A: LAN5P+LAU11L+NL41+LAN3P+LAV90L+LAN2L  
 B: LAN1P+LAV90L+NL41+LAN4L+LAU11L+LAN6L

SYMBOL		WYMIARY [mm]					PLN	kg m3 szt	UWAGI	
A	B	W <sub>1</sub>	W <sub>2</sub>	D <sub>1</sub>	D <sub>2</sub>	H				
<b>LAV86L</b>	<b>LAV87L</b>	2638	1835	1600	937	1105	190.8	1.328	13	

A

B

A: LAN1P+LAV64L+NL41+LAN4L+LAV66L+LAN6L  
 B: LAN5P+LAV66L+NL41+LAN3P+LAV64L+LAN2L

SYMBOL		WYMIARY [mm]					PLN	kg m3 szt	UWAGI	
A	B	W <sub>1</sub>	W <sub>2</sub>	D <sub>1</sub>	D <sub>2</sub>	H				
<b>LAV30L</b>	<b>LAV31L</b>	2922	1486	-	-	1105	171.8	1.280	12	

A

B

A: LAN1P+LAV62L+NL41+LAN4L+LAV66L+LAN6L  
 B: LAN5P+LAV66L+NL41+LAN3P+LAV62L+LAN2L

SYMBOL		WYMIARY [mm]					PLN	kg m3 szt	UWAGI	
A	B	W <sub>1</sub>	W <sub>2</sub>	D <sub>1</sub>	D <sub>2</sub>	H				
<b>LAV32L</b>	<b>LAV33L</b>	3452	1502	1720	1225	1105	182.8	1.366	13	

LEGENDA:

- WAGA NETTO

- OBJĘTOŚĆ

- ILOŚĆ PACZEK

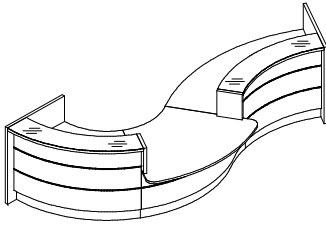
**UKŁADY LAD**

A

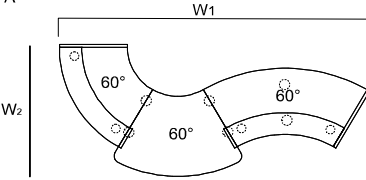

B

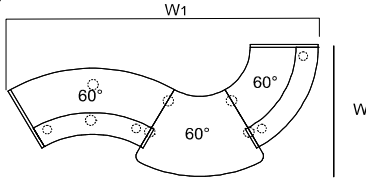

A: LAN1P+LAV64L+NL41+LAN4L+LAV66L+NL41+LAN3P+LAV62L+LAN2L  
 B: LAN1P+LAV62L+NL41+LAN4L+LAV66L+NL41+LAN3P+LAV64L+LAN2L

SYMBOL		WYMIARY [mm]					PLN				UWAGI
A	B	W <sub>1</sub>	W <sub>2</sub>	D <sub>1</sub>	D <sub>2</sub>	H		kg	m <sup>3</sup>	szt	
<b>LAV34L</b>	<b>LAV35L</b>	4195	1835	-	1503	1105		262.1	2.129	20	

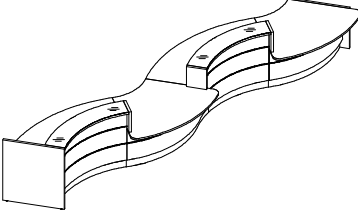

A

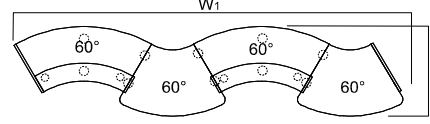

B

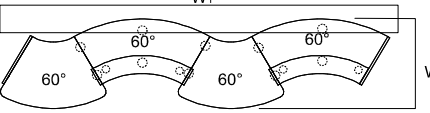

A: LAN1P+LAV62L+NL41+LAN4L+LAV66L+NL41+LAN3P+LAV62L+NL41+LAN4L+LAV66L+LAN6L  
 B: LAN5P+LAV66L+NL41+LAN3P+LAV62L+NL41+LAN4L+LAV66L+NL41+LAN3P+LAV62L+LAN2L

SYMBOL		WYMIARY [mm]					PLN				UWAGI
A	B	W <sub>1</sub>	W <sub>2</sub>	D <sub>1</sub>	D <sub>2</sub>	H		kg	m <sup>3</sup>	szt	
<b>LAV36L</b>	<b>LAV37L</b>	6352	1503	-	-	1105		322.1	2.706	24	

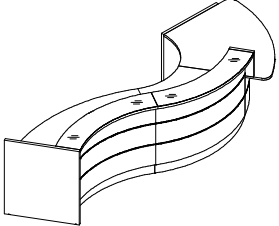

A

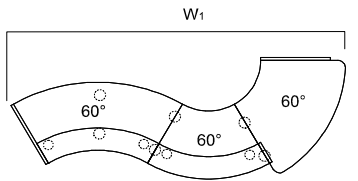

B

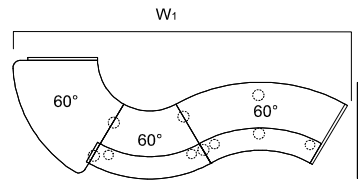

A: LAN1P+LAV62L+NL41+LAV64L+NL41+LAN4L+LAV66L+LAN6L  
 B: LAN5P+LAV66L+NL41+LAN3P+LAV64L+NL41+LAV62L+LAN2L

SYMBOL		WYMIARY [mm]					PLN				UWAGI
A	B	W <sub>1</sub>	W <sub>2</sub>	D <sub>1</sub>	D <sub>2</sub>	H		kg	m <sup>3</sup>	szt	
<b>LAV38L</b>	<b>LAV39L</b>	4386	1639	-	1307	1105		252.3	2.106	19	

LEGENDA:

- WAGA NETTO

- OBJĘTOŚĆ

- ILOŚĆ PACZEK

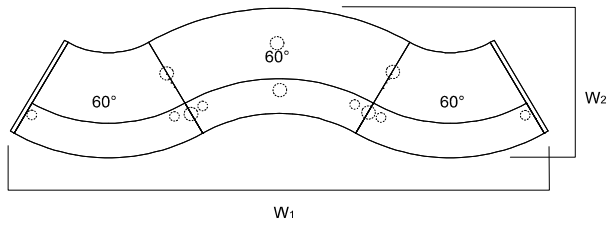
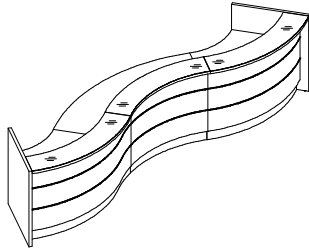

**UKŁADY LAD**

LAN1P+LAV64L+NL41+LAV62L+NL41+LAV64L+LAN2L

SYMBOL	WYMIARY [mm]					PLN				UWAGI
	W <sub>1</sub>	W <sub>2</sub>	D <sub>1</sub>	D <sub>2</sub>	H		kg	m <sup>3</sup>	szt	
<b>LAV50L</b>	4566	1307	-	-	1105		269.5	2.345	20	

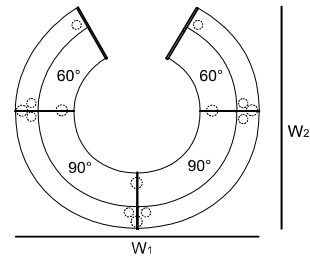
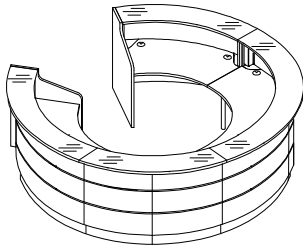

LWN1P+LWC64L+NL41+LWC90L+NL41+LWC90L+NL41+LWC64L+LWN2L

SYMBOL	WYMIARY [mm]					PLN				UWAGI
	W <sub>1</sub>	W <sub>2</sub>	D <sub>1</sub>	D <sub>2</sub>	H		kg	m <sup>3</sup>	szt	
<b>LAV51L</b>	3202	3006	-	-	1105		410.0	3.741	27	

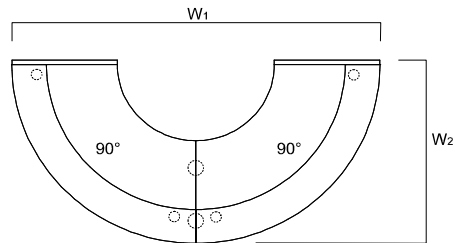
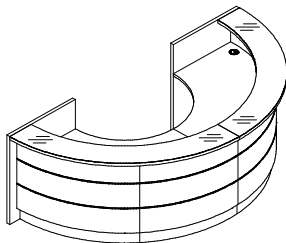

LAN1P+LAV90L+NL41+LAV90L+LAN2L

SYMBOL	WYMIARY [mm]					PLN				UWAGI
	W <sub>1</sub>	W <sub>2</sub>	D <sub>1</sub>	D <sub>2</sub>	H		kg	m <sup>3</sup>	szt	
<b>LAV52L</b>	3202	1639	-	-	1105		271.0	2.261	15	

LEGENDA:



- WAGA NETTO

- OBJĘTOŚĆ

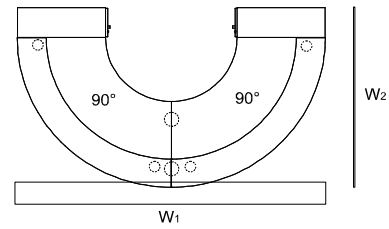
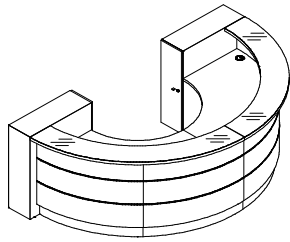
- ILOŚĆ PACZEK



**UKŁADY LAD**

LAD10+LAP10+LAV90L+NL41+LAV90L+LAL10+LAD10

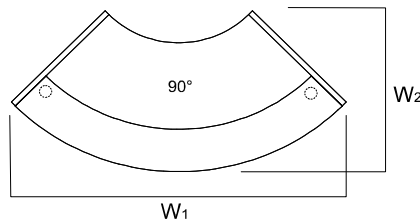
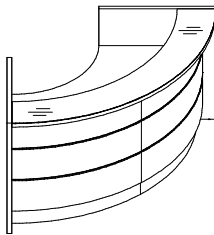
SYMBOL	WYMIARY [mm]					PLN				UWAGI
	W <sub>1</sub>	W <sub>2</sub>	D <sub>1</sub>	D <sub>2</sub>	H		kg	m <sup>3</sup>	szt	
<b>LAV61L</b>	3202	1919	-	-	1105		329.0	2.923	17	



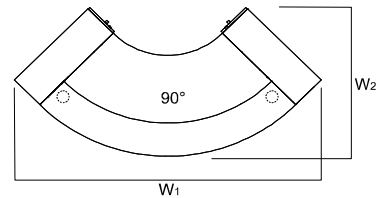
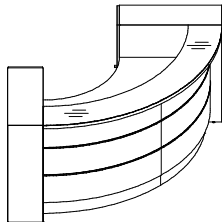

LAN1P+LAV90L+LAN2L

SYMBOL	WYMIARY [mm]					PLN				UWAGI
	W <sub>1</sub>	W <sub>2</sub>	D <sub>1</sub>	D <sub>2</sub>	H		kg	m <sup>3</sup>	szt	
<b>LAV53L</b>	2317	1145	-	-	1105		162.5	1.213	9	



LAD10+LAP10+LAV90L+LAL10+LAD10

SYMBOL	WYMIARY [mm]					PLN				UWAGI
	W <sub>1</sub>	W <sub>2</sub>	D <sub>1</sub>	D <sub>2</sub>	H		kg	m <sup>3</sup>	szt	
<b>LAV73L</b>	2713	1353	-	-	1105		218.5	1.813	10	

LEGENDA:

 - WAGA NETTO

 - OBJĘTOŚĆ

 - ILOŚĆ PACZEK

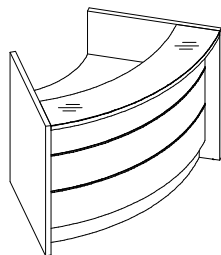
**UKŁADY LAD**

LAN1P+LAV64L+LAN2L

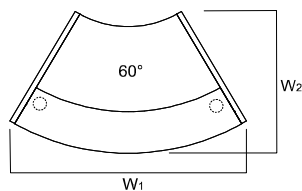

SYMBOL	WYMIARY [mm]					PLN				UWAGI
	W <sub>1</sub>	W <sub>2</sub>	D <sub>1</sub>	D <sub>2</sub>	H		kg	m <sup>3</sup>	szt	
LAV54L	1666	1029	-	-	1105		119.5	0.779	7	

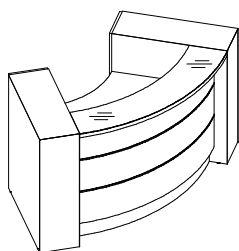

LAD10+LAP10+LAV64L+LAL10+LAD10

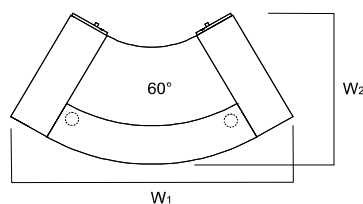

SYMBOL	WYMIARY [mm]					PLN				UWAGI
	W <sub>1</sub>	W <sub>2</sub>	D <sub>1</sub>	D <sub>2</sub>	H		kg	m <sup>3</sup>	szt	
LAV74L	2151	1183	-	-	1105		177.5	1.442	9	

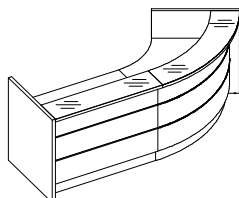
<sup>13</sup>  
<sup>16</sup>  
 A: LAN1P+LA23L+NL41+LAV64L+LAN2L

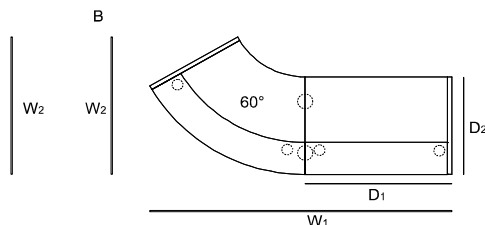
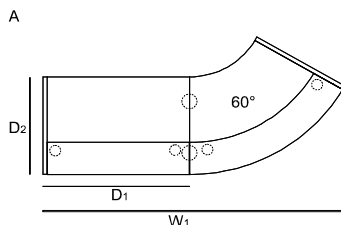
<sup>13</sup>  
<sup>16</sup>  
 B: LAN1P+LAV64L+NL41+LA23L+LAN2L

SYMBOL		WYMIARY [mm]					PLN				UWAGI
A	B	W <sub>1</sub>	W <sub>2</sub>	D <sub>1</sub>	D <sub>2</sub>	H		kg	m <sup>3</sup>	szt	
LAV78L <sup>13</sup>	LAV79L <sup>13</sup>	2733	1292	1328	917	1105		178.1	1.071	13	
LAV80L <sup>16</sup>	LAV81L <sup>16</sup>	3033	1292	1628	917	1105		191.5	1.118	13	
LAV82L <sup>23</sup>	LAV83L <sup>23</sup>	3733	1292	2318	917	1105		218.0	1.257	14	

LEGENDA:

- WAGA NETTO

- OBJĘTOŚĆ

- ILOŚĆ PACZEK

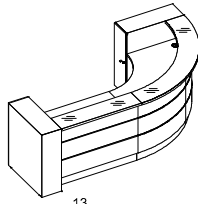
**UKŁADY LAD**

A: LAD10+LAP10+LA23L+NL41+LAV90L+LAL10+LAD10

B: LAD10+LAP10+LAV90L+NL41+LA23L+LAL10+LAD10

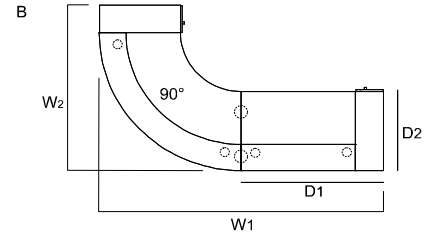
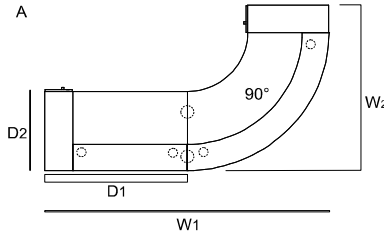

SYMBOL		WYMIARY [mm]					PLN	kg	m <sup>3</sup>	szt	UWAGI
A	B	W <sub>1</sub>	W <sub>2</sub>	D <sub>1</sub>	D <sub>2</sub>	H					
LAV55L <sup>13</sup>	LAV56L <sup>13</sup>	3208	1918	1608	937	1105	277.1	2.104	16		
LAV57L <sup>16</sup>	LAV58L <sup>16</sup>	3508	1918	1908	937	1105	290.5	2.151	16		
LAV59L <sup>23</sup>	LAV60L <sup>23</sup>	4208	1918	2608	937	1105	317.0	2.291	17		

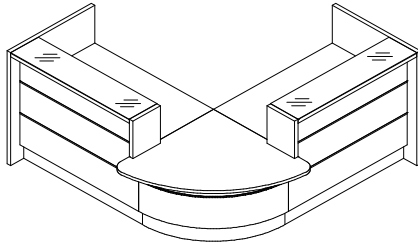

LAN1P+LA23L+NL41+LAN4L+LAV68L+NL41+LAN3P+LA23L+LAN2L

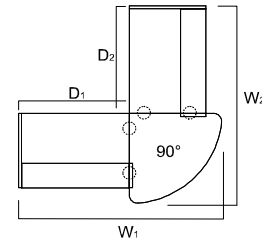

SYMBOL		WYMIARY [mm]					PLN	kg	m <sup>3</sup>	szt	UWAGI
		W <sub>1</sub>	W <sub>2</sub>	D <sub>1</sub>	D <sub>2</sub>	H					
LAV101L <sup>13</sup>	LAV101L <sup>13</sup>	2437	2437	1328	1328	1105	207.3	0.955	18		
LAV102L <sup>13</sup>	LAV102L <sup>16</sup>	2437	2737	1328	1628	1105	220.7	1.002	18		
LAV103L <sup>13</sup>	LAV103L <sup>23</sup>	2437	3437	1328	2318	1105	247.2	1.141	19		
LAV104L <sup>16</sup>	LAV104L <sup>13</sup>	2737	2437	1628	1328	1105	220.7	1.002	18		
LAV105L <sup>16</sup>	LAV105L <sup>16</sup>	2737	2737	1628	1628	1105	234.1	1.049	18		
LAV106L <sup>16</sup>	LAV106L <sup>23</sup>	2737	3437	1628	2318	1105	260.6	1.189	19		
LAV107L <sup>23</sup>	LAV107L <sup>13</sup>	3437	2437	2318	1328	1105	247.2	1.141	19		
LAV108L <sup>23</sup>	LAV108L <sup>16</sup>	3437	2737	2318	1628	1105	260.6	1.189	19		
LAV109L <sup>23</sup>	LAV109L <sup>23</sup>	3437	3437	2318	2318	1105	285.6	1.311	19		

LEGENDA:

- WAGA NETTO

- OBJĘTOŚĆ

- ILOŚĆ PACZEK

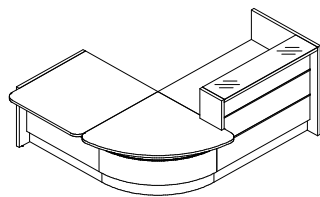
**UKŁADY LAD**

A: LAN5+LAU11L+NL41+LAV68L+NL41+LAN3+LA23L+LAN2<sup>13</sup>  
 B: LAN1+LA23L+NL41+LAN4+LAV68L+NL41+LAN11L+LAN6<sup>16</sup>

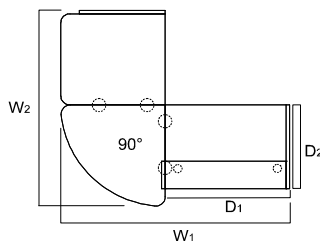
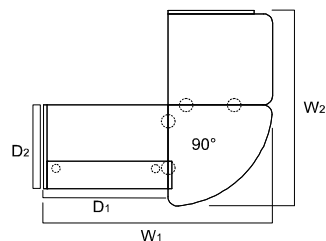
**A**

**B**

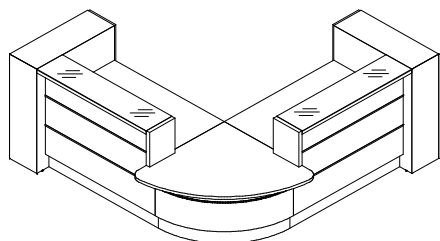
SYMBOL		WYMIARY [mm]					PLN	kg	m3	szt	UWAGI
A	B	W <sub>1</sub>	W <sub>2</sub>	D <sub>1</sub>	D <sub>2</sub>	H					
LAV110L <sup>13</sup>	LAV111L <sup>13</sup>	2442	2147	1328	917	1105	176.4	0.832	16		
LAV112L <sup>16</sup>	LAV113L <sup>16</sup>	2742	2147	1628	917	1105	189.8	0.879	16		
LAV114L <sup>23</sup>	LAV115L <sup>23</sup>	3442	2147	2318	917	1105	216.3	1.019	17		

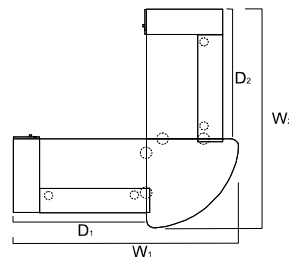

LAD10+LAP10+LA23L+NL41+LAN4L+LAV68L+NL41+LAN3P+LA23L+LAL10+LAD10<sup>13</sup>



SYMBOL		WYMIARY [mm]					PLN	kg	m3	szt	UWAGI
		W <sub>1</sub>	W <sub>2</sub>	D <sub>1</sub>	D <sub>2</sub>	H					
LAV116L <sup>13</sup>	LAV117L <sup>16</sup>	2717	2717	1608	1608	1105	265.3	1.617	20		
LAV117L <sup>16</sup>	LAV118L <sup>23</sup>	2717	3017	1608	1908	1105	278.7	1.664	20		
LAV118L <sup>23</sup>	LAV119L <sup>13</sup>	2717	3717	1608	2608	1105	305.2	1.804	21		
LAV119L <sup>13</sup>	LAV120L <sup>16</sup>	3017	2717	1908	1608	1105	278.7	1.664	20		
LAV120L <sup>16</sup>	LAV121L <sup>23</sup>	3017	3017	1908	1908	1105	292.1	1.711	20		
LAV121L <sup>23</sup>	LAV122L <sup>13</sup>	3017	3717	1908	2608	1105	318.6	1.851	21		
LAV122L <sup>13</sup>	LAV123L <sup>16</sup>	3717	2717	2608	1608	1105	305.2	1.804	21		
LAV123L <sup>16</sup>	LAV124L <sup>23</sup>	3717	3017	2608	1908	1105	318.6	1.851	21		
LAV124L <sup>23</sup>		3717	3717	2608	2608	1105	343.6	1.973	21		

LEGENDA:

- WAGA NETTO

- OBJĘTOŚĆ

- ILOŚĆ PACZEK

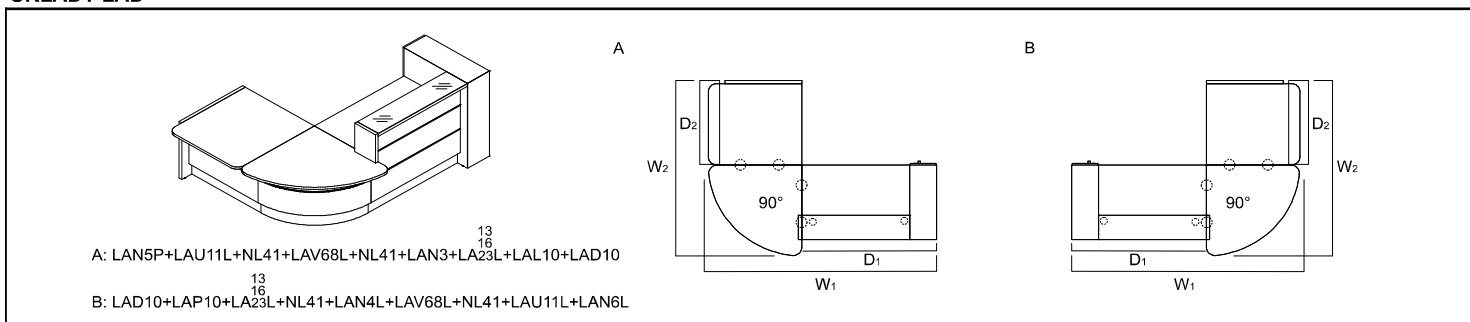
**UKŁADY LAD**

SYMBOL		WYMIARY [mm]					PLN	kg	m3	szt	UWAGI
A	B	W <sub>1</sub>	W <sub>2</sub>	D <sub>1</sub>	D <sub>2</sub>	H					
LAV125L <sup>13</sup>	LAV126L <sup>13</sup>	2722	2147	1608	1038	1105	210.4	1.181	18		
LAV127L <sup>16</sup>	LAV128L <sup>16</sup>	3022	2147	1908	1038	1105	214.8	1.204	17		
LAV129L <sup>23</sup>	LAV130L <sup>23</sup>	3722	2147	2608	1038	1105	245.3	1.350	18		

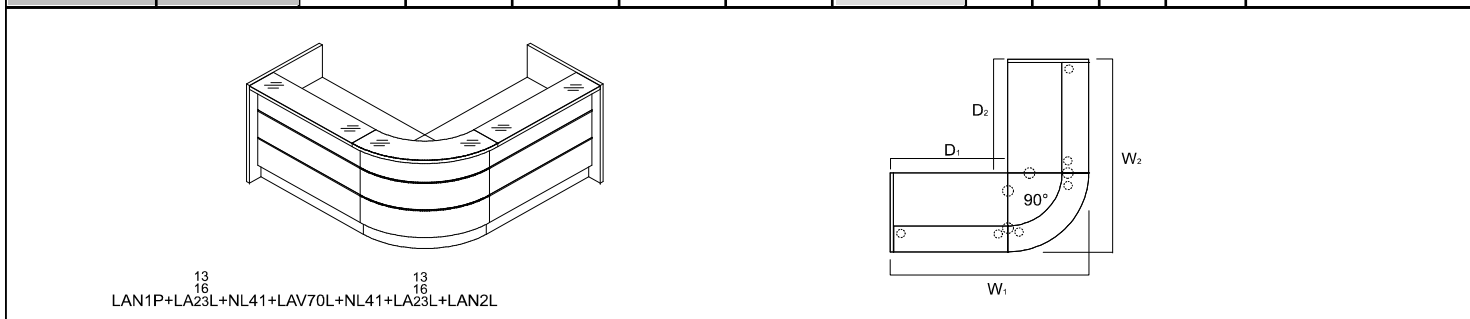

SYMBOL		WYMIARY [mm]					PLN	kg	m3	szt	UWAGI
		W <sub>1</sub>	W <sub>2</sub>	D <sub>1</sub>	D <sub>2</sub>	H					
LAV131L <sup>13</sup>	LAV131L <sup>13</sup>	2245	2245	1328	1328	1105	209.7	1.041	17		
LAV132L <sup>13</sup>	LAV132L <sup>16</sup>	2245	2545	1328	1628	1105	223.1	1.088	17		
LAV133L <sup>13</sup>	LAV133L <sup>23</sup>	2245	3245	1328	2318	1105	249.6	1.228	18		
LAV134L <sup>16</sup>	LAV134L <sup>13</sup>	2545	2245	1628	1328	1105	223.1	1.088	17		
LAV135L <sup>16</sup>	LAV135L <sup>16</sup>	2545	2545	1628	1628	1105	236.5	1.136	17		
LAV136L <sup>16</sup>	LAV136L <sup>23</sup>	2545	3245	1628	2318	1105	263.0	1.275	18		
LAV137L <sup>23</sup>	LAV137L <sup>13</sup>	3245	2245	2318	1328	1105	249.6	1.228	18		
LAV138L <sup>23</sup>	LAV138L <sup>16</sup>	3245	2545	2318	1628	1105	263.0	1.275	18		
LAV139L <sup>23</sup>	LAV139L <sup>23</sup>	3245	3245	2318	2318	1105	288.0	1.397	18		

LEGENDA:

- WAGA NETTO

- OBJĘTOŚĆ

- ILOŚĆ PACZEK

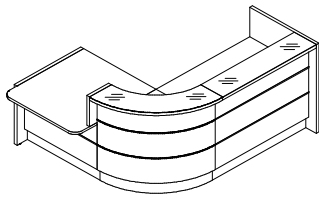
**UKŁADY LAD**

A: LAN5P+LAU11L+NL41+LAN3P+LAN70L+NL41+LA23L+LAN2L  
 B: LAN1P+LA23L+NL41+LAV70L+NL41+LAN4L+LAU11L+LAN6L

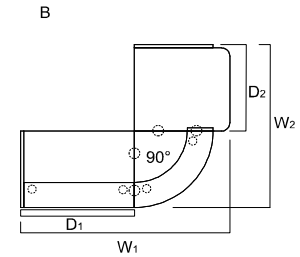
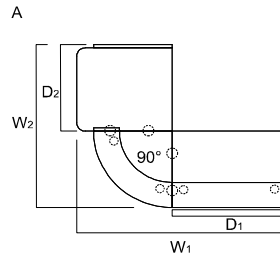

SYMBOL		WYMIARY [mm]					PLN	kg	m3	szt	UWAGI
A	B	W <sub>1</sub>	W <sub>2</sub>	D <sub>1</sub>	D <sub>2</sub>	H					
LAV140L <sup>13</sup>	LAV141L <sup>13</sup>	2442	1955	1328	1038	1105	184.4	0.933	17		
LAV142L <sup>16</sup>	LAV143L <sup>16</sup>	2742	1955	1628	1038	1105	197.8	0.980	17		
LAV144L <sup>23</sup>	LAV145L <sup>23</sup>	3442	1955	2318	1038	1105	224.3	1.119	18		

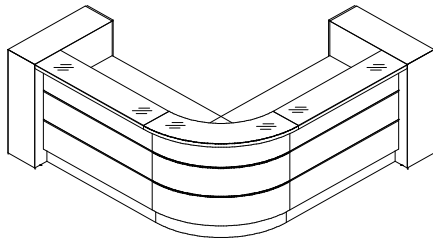

LAD10+LAP10+LA23L+NL41+LAV70L+NL41+LA23L+LAL10+LAD10

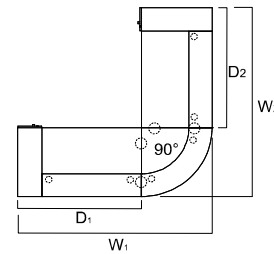

SYMBOL		WYMIARY [mm]					PLN	kg	m3	szt	UWAGI
		W <sub>1</sub>	W <sub>2</sub>	D <sub>1</sub>	D <sub>2</sub>	H					
LAV146L <sup>13</sup>	LAV146L <sup>13</sup>	2525	2525	1608	1608	1105	267.7	1.704	19		
LAV147L <sup>13</sup>	LAV147L <sup>16</sup>	2525	2825	1608	1908	1105	281.1	1.751	19		
LAV148L <sup>13</sup>	LAV148L <sup>23</sup>	2525	3525	1608	2608	1105	307.6	1.890	20		
LAV149L <sup>16</sup>	LAV149L <sup>13</sup>	2825	2525	1908	1608	1105	281.1	1.751	19		
LAV150L <sup>16</sup>	LAV150L <sup>16</sup>	2825	2825	1908	1908	1105	294.5	1.798	19		
LAV151L <sup>16</sup>	LAV151L <sup>23</sup>	2825	3525	1908	2608	1105	321.0	1.937	20		
LAV152L <sup>23</sup>	LAV152L <sup>13</sup>	3525	2525	2608	1608	1105	307.6	1.890	20		
LAV153L <sup>23</sup>	LAV153L <sup>16</sup>	2525	2825	2608	1908	1105	321.0	1.937	20		
LAV154L <sup>23</sup>	LAV154L <sup>23</sup>	3525	3525	2608	2608	1105	346.0	2.060	20		

LEGENDA:

- WAGA NETTO

- OBJĘTOŚĆ

- ILOŚĆ PACZEK

**UKŁADY LAD**

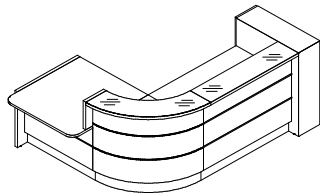

A:

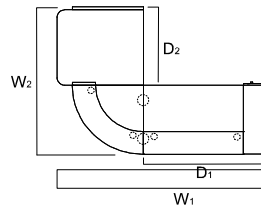

B:

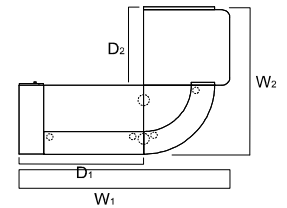

A: LAN5P+LAU11L+NL41+LAN3P+LWC70L+NL41+LW23L+LWL10+LWD10

B: LWD10+LWP10+LW23L+NL41+LWC70L+NL41+LWN4L+LWU11L+LWN6L

SYMBOL		WYMIARY [mm]					PLN	kg	m3	szt	UWAGI
A	B	W <sub>1</sub>	W <sub>2</sub>	D <sub>1</sub>	D <sub>2</sub>	H					
LAV155L <sup>13</sup>	LAV156L <sup>13</sup>	2722	1955	1608	1038	1105	218.4	1.282	19		
LAV157L <sup>16</sup>	LAV158L <sup>16</sup>	3022	1955	1908	1038	1105	222.8	1.305	18		
LAV159L <sup>23</sup>	LAV160L <sup>23</sup>	3722	1955	2608	1038	1105	253.3	1.451	19		

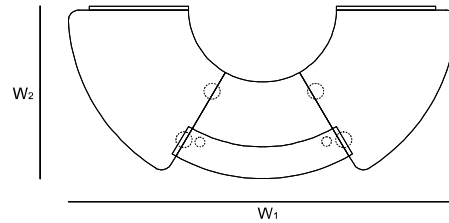
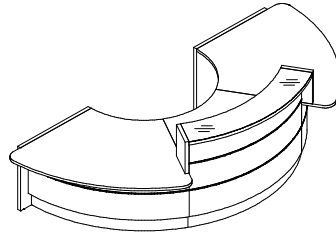

LAN5P+LAV66L+LAN3P+NL41+LAV64L+LAN4L+NL41+LAV66L+LAN6L

SYMBOL	WYMIARY [mm]					PLN	kg	m3	szt	UWAGI
	W <sub>1</sub>	W <sub>2</sub>	D <sub>1</sub>	D <sub>2</sub>	H					
LAV05L	3589	1629	-	-	1105	224.1	1.781	17		

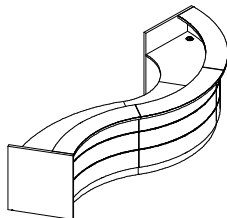

A:

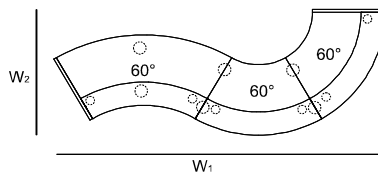

B:

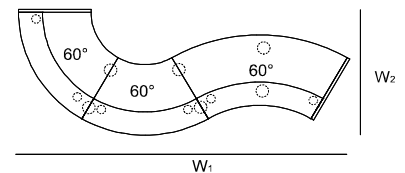

A: LAN1P+LAV62L+NL41+LAV64L+NL41+LAV64L+LAN2L

B: LAN1P+LAV64L+NL41+LAV64L+NL41+LAV62L+LAN2L

SYMBOL		WYMIARY [mm]					PLN	kg	m3	szt	UWAGI
A	B	W <sub>1</sub>	W <sub>2</sub>	D <sub>1</sub>	D <sub>2</sub>	H					
LAV06L	LAV07L	4199	1629	-	-	1105	269.5	2.345	20		

LEGENDA:

- WAGA NETTO

- OBJĘTOŚĆ



- ILOŚĆ PACZEK

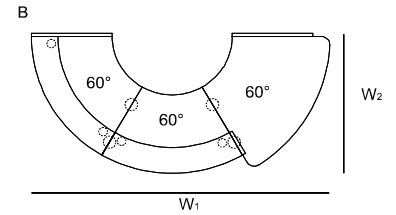
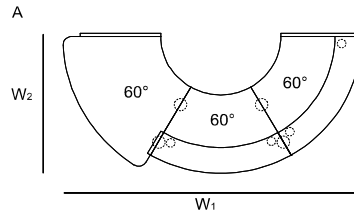
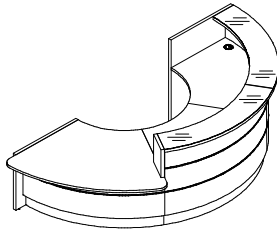

**UKŁADY LAD**



A: LAN5P+LAV66L+NL41+LAN3P+LAV64L+NL41+LAV64L+LAN2L

B: LAN1P+LAV64L+NL41+LAV64L+NL41+LAN4L+LAV66L+LAN6L



SYMBOL		WYMIARY					[mm]	PLN					UWAGI
A	B	W <sub>1</sub>	W <sub>2</sub>	D <sub>1</sub>	D <sub>2</sub>	H							
LAV08L	LAV09L	3367	1629	-	-	1105		235.3	2.009	16			

LEGENDA:



 - WAGA NETTO

 - OBJĘTOŚĆ

 - ILOŚĆ PACZEK

WIDOK I RZUT OBIEKTU	WYMIARY [mm]			SYMBOL	CENA NETTO PLN				UWAGI
	SZEROKOŚĆ	GLĘBOKOŚĆ	WYSOKOŚĆ			kg	m3	szt	

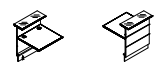
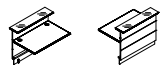
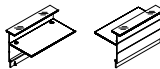
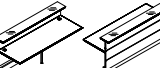
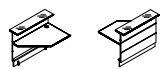
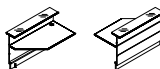
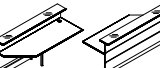
**ELEMENTY SKŁADOWE PROSTE**

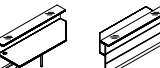
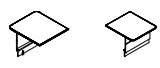

	844	917	1105	<b>LA09L</b>		37.0	0.153	6	
	1290	917	1105	<b>LA13L</b>		57.6	0.233	7	
	1590	917	1105	<b>LA16L</b>		71.0	0.280	7	
	2290	917	1105	<b>LA23L</b>		97.5	0.419	8	blat zawsze z nogą NE41
	1290	917	1105	<b>LAP13L</b>		56.6	0.233	7	
	1590	917	1105	<b>LAP16L</b>		70.5	0.280	7	
	2290	917	1105	<b>LAP23L</b>		97.0	0.419	8	blat zawsze z nogą NE41
	1290	917	1105	<b>LAL13L</b>		56.6	0.233	7	
	1590	917	1105	<b>LAL16L</b>		70.5	0.280	7	
	2290	917	1105	<b>LAL23L</b>		97.0	0.419	8	
	1000	1114	740	<b>LAU11L</b>		33.5	0.128	5	

## LEGENDA:





 - WAGA NETTO

 - OBJĘTOŚĆ

 - ILOŚĆ PACZEK

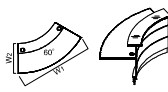
WIDOK i RZUT OBIEKTU	WYMIARY [mm]			SYMBOL	CENA NETTO PLN				UWAGI
	SZEROKOŚĆ	GŁĘBOKOŚĆ	WYSOKOŚĆ			kg	m3	szt	

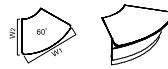
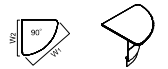
**ELEMENTY SKŁADOWE ŁUKOWE**

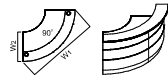
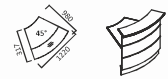

	2216	917	1105	<b>LAV62L</b>		79.5	0.767	8	
	1600	917	1105	<b>LAV64L</b>		68.5	0.681	7	
	1720	1109	740	<b>LAV66L</b>		54.5	0.446	3	
	1485	1109	740	<b>LAV68L</b>		35.5	0.260	3	
	1297	917	1105	<b>LAV70L</b>		43.5	0.361	4	
	2264	917	1105	<b>LAV90L</b>		137.5	1.128	9	
	1225	917	1105	<b>LAV63L</b>		54.5	0.506	6	

LEGENDA:

 - WAGA NETTO

 - OBJĘTOŚĆ

 - ILOŚĆ PACZEK

WIDOK i RZUT OBIEKTU	WYMIARY [mm]			SYMBOL	CENA NETTO PLN				UWAGI
	SZEROKOŚĆ	GLĘBOKOŚĆ	WYSOKOŚĆ			kg	m3	szt	

**ELEMENTY SKŁADOWE**

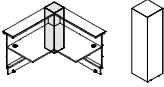
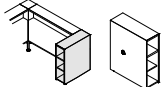
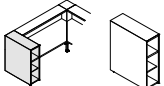
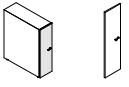
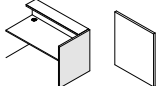
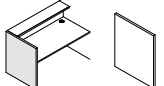
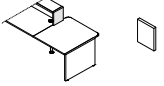
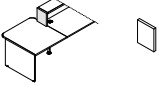

	300	300	1105	<b>LA100</b>		22.2	0.115	1	"kostka zamknięta" narożna
	318	917	1105	<b>LAP10</b>		50.0	0.364	1	kostka z regalem prawa
	318	917	1105	<b>LAL10</b>		50.0	0.364	1	kostka z regalem lewa
	306	20	1088	<b>LAD10</b>		5.0	0.018	1	drzwi uniwersalne do LWP10 i LWL10
	38	917	1105	<b>LAN1P</b>		26.0	0.051	1	bok lady wysokiej -prawy
	38	917	1105	<b>LAN2L</b>		26.0	0.051	1	bok lady wysokiej - lewy
	38	300	364	<b>LAN3P</b>		2.8	0.007	1	bok do łączenia lady niskiej i wysokiej, prawy
	38	300	364	<b>LAN4L</b>		2.8	0.007	1	bok do łączenia lady niskiej i wysokiej, lewy

## LEGENDA:







 - WAGA NETTO

 - OBJĘTOŚĆ

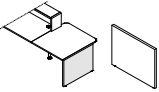
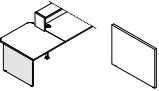
 - ILOŚĆ PACZEK

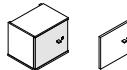
WIDOK i RZUT OBIEKTU	WYMIARY [mm]			SYMBOL	CENA NETTO PLN				UWAGI
	SZEROKOŚĆ	GLĘBOKOŚĆ	WYSOKOŚĆ			kg	m3	szt	

**ELEMENTY SKŁADOWE**

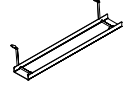
	38	917	740	<b>LAN5P</b>		19.0	0.036	1	noga do lady niskiej, prawa
	38	917	740	<b>LAN6L</b>		19.0	0.036	1	noga do lady niskiej, lewa
	345	283	314	<b>LMS05</b>		5.0	0.031	1	
	339	18	286	<b>LMS06</b>		2.0	0.005	1	
	585	142	690	<b>NL41</b>		2.0	0.063	1	
	40	40	712	<b>NE41</b>		1.5	0.017	1	noga okrągła
	140	70	750	<b>S81</b>		1.1	0.008	1	przewodzenie kabli (kręgosłup) kolor 09-aluminium
	460	70	87	<b>E64</b>		0.0	0.000	0	kanal kablowy 09-aluminium

## LEGENDA:

 - WAGA NETTO

 - OBJĘTOŚĆ

 - ILOŚĆ PACZEK