

OPIS TECHNICZNY

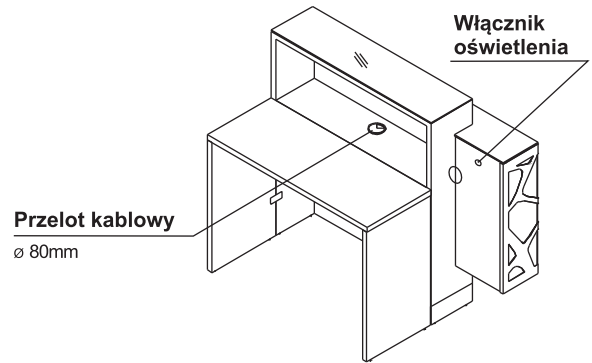

WYMIARY

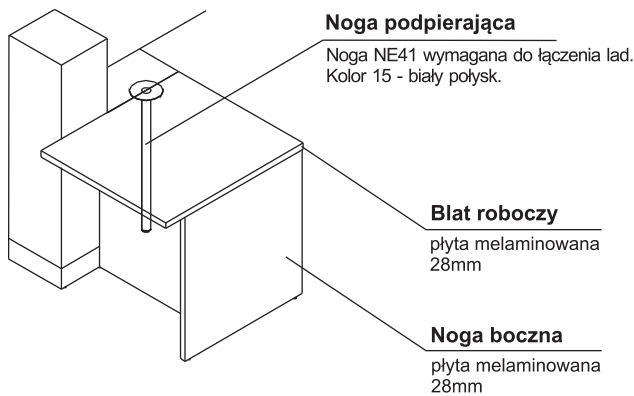
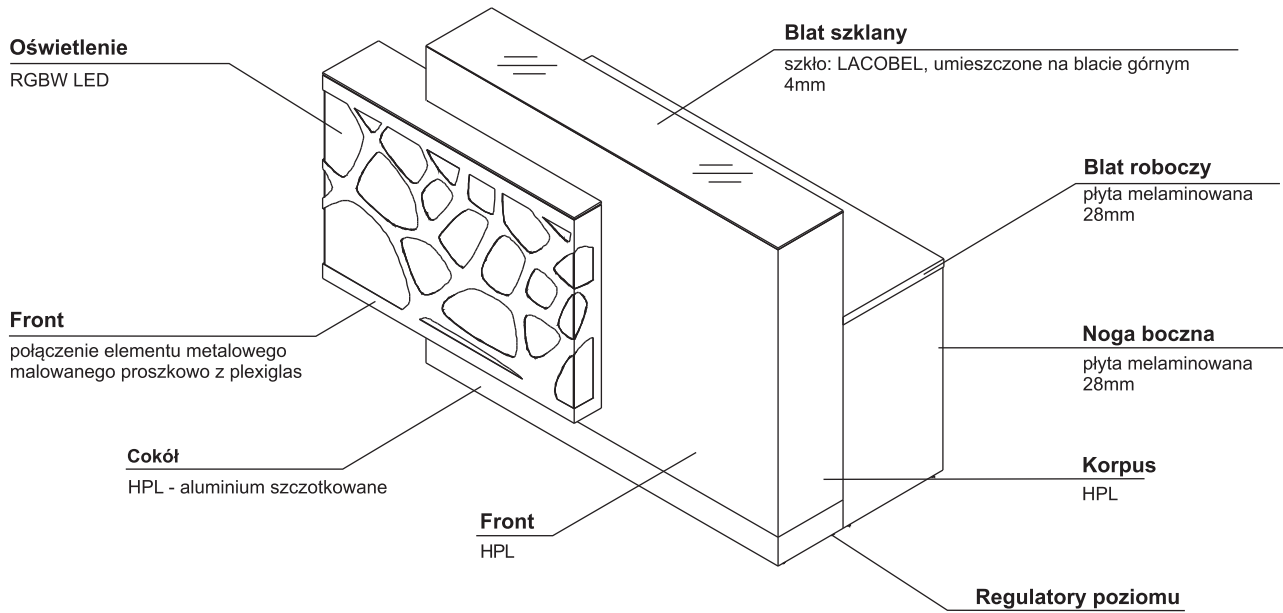
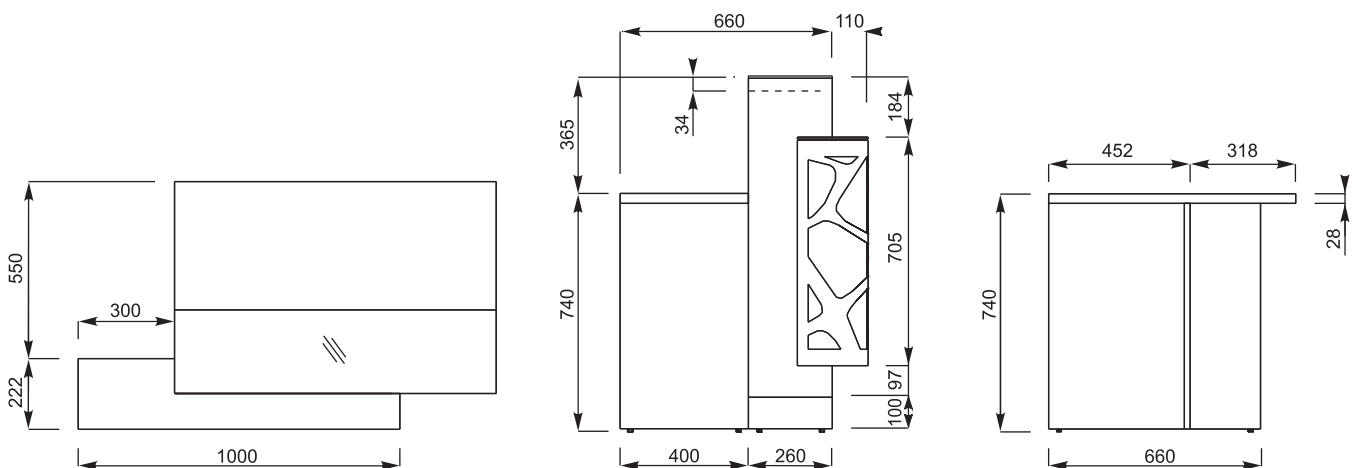

ORGANIC

67-BIAŁY PASTEL

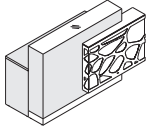

LACOBEL, BIAŁY

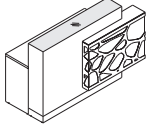

15 - BIAŁY POŁYSK

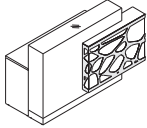

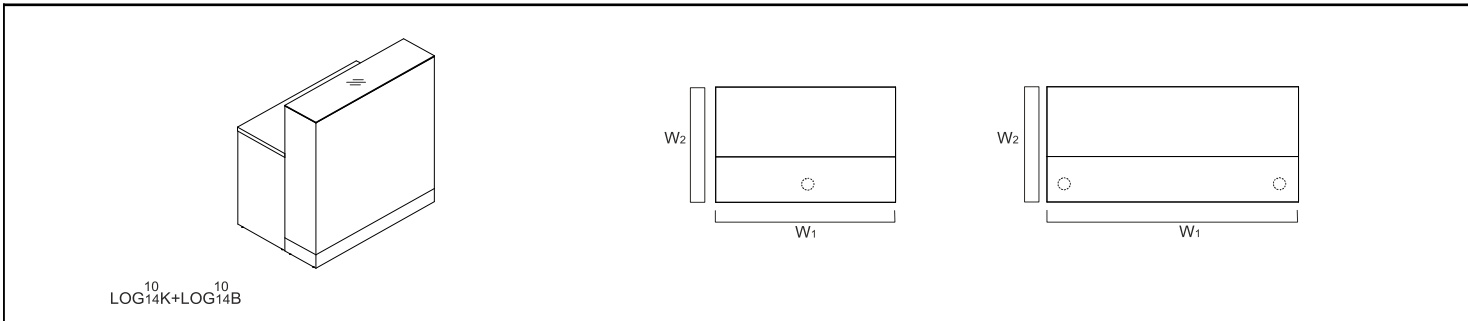
UKŁADY LAD

LOG10K+LOG14B

SYMBOL	WYMIARY [mm]					PLN				UWAGI
	W ₁	W ₂	D ₁	D ₂	H		kg	m ³	szt	
LOG10G	1000	660	-	-	1105		50.0	0.582	2	
LOG14G	1400	660	-	-	1105		55.0	0.815	2	

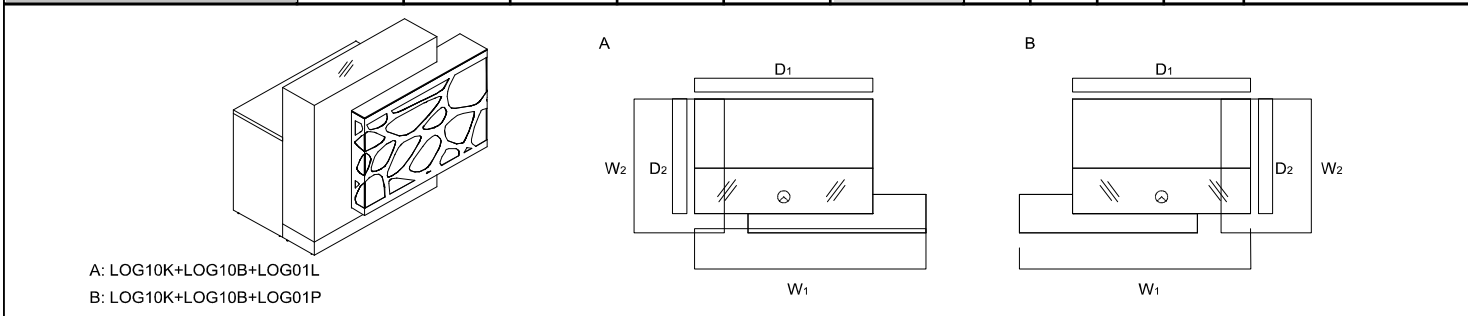
 A: LOG10K+LOG10B+LOG01L
 B: LOG10K+LOG10B+LOG01P

SYMBOL		WYMIARY [mm]					PLN				UWAGI
A	B	W ₁	W ₂	D ₁	D ₂	H		kg	m ³	szt	
LOG11LG	LOG11PG	1300	770	1000	660	1105		59.5	0.745	6	

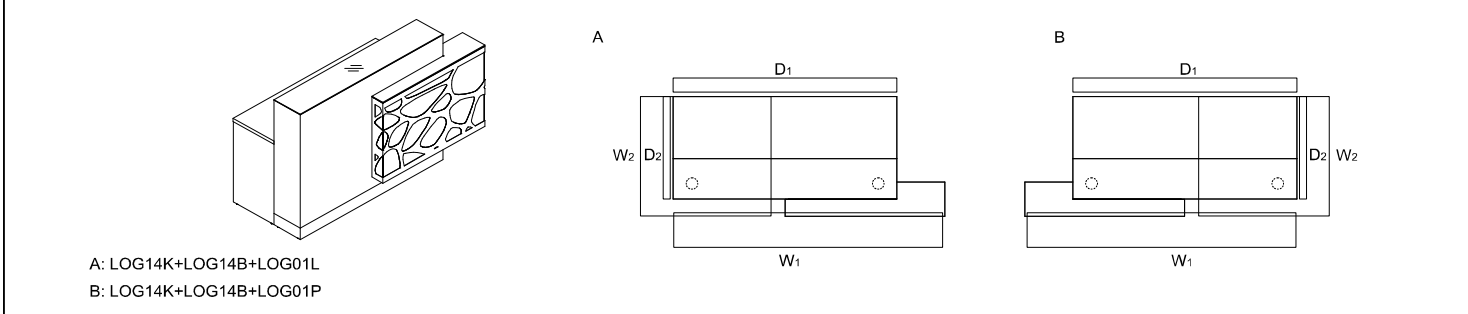
 A: LOG14K+LOG14B+LOG01L
 B: LOG14K+LOG14B+LOG01P

SYMBOL		WYMIARY [mm]					PLN				UWAGI
A	B	W ₁	W ₂	D ₁	D ₂	H		kg	m ³	szt	
LOG12LG	LOG12PG	1700	770	1400	660	1105		64.5	0.978	6	

LEGENDA:

- WAGA NETTO

- OBJĘTOŚĆ

- ILOŚĆ PACZEK

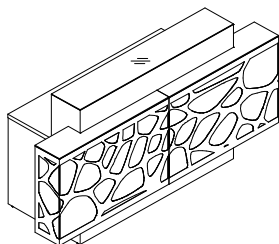
UKŁADY ŁAD

LOG14K+LOG14B+LOG01L+LOG01P

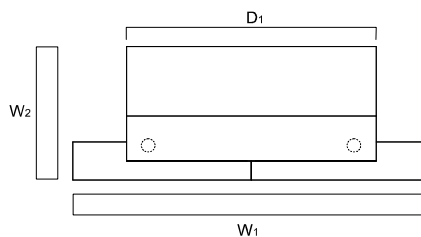

SYMBOL	WYMIARY [mm]					PLN				UWAGI
	W ₁	W ₂	D ₁	D ₂	H		kg	m ³	szt	
LOG13G	2000	770	1400	-	1105		74.0	1.141	10	

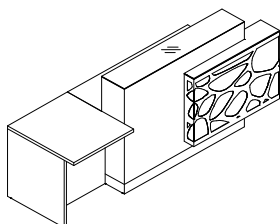
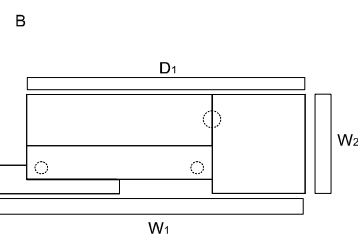
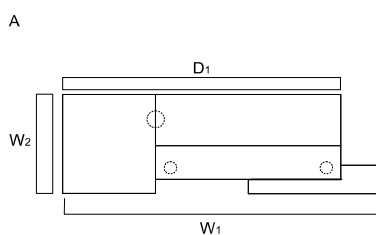
 A: LOG07+NE41+LOG14K+LOG14B+LOG01L
 B: LOG01P+LOG14K+LOG14B+NE41+LOG07

SYMBOL		WYMIARY [mm]					PLN				UWAGI
A	B	W ₁	W ₂	D ₁	D ₂	H		kg	m ³	szt	
LOG14PLG	LOG14PPG	2400	770	2100	-	1105		77.8	1.027	8	

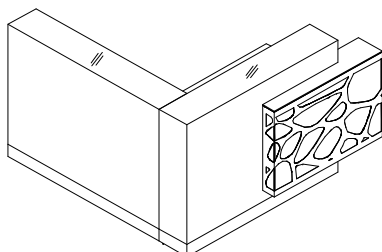
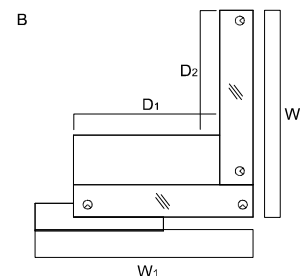
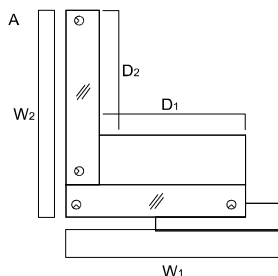
 A: 2xLOG14K+LOG11B+LOG01L
 B: LOG01P+2xLOG14K+LOG11B

SYMBOL		WYMIARY [mm]					PLN				UWAGI
A	B	W ₁	W ₂	D ₁	D ₂	H		kg	m ³	szt	
LOG16LG	LOG16PG	1700	1660	1140	1000	1105		104.5	1.301	7	

LEGENDA:

- WAGA NETTO

- OBJĘTOŚĆ

- ILOŚĆ PACZEK

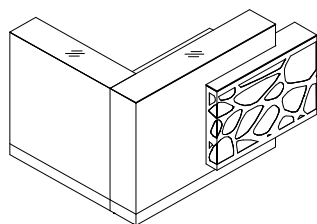
UKŁADY LAD

A: LOG10K+LOG14K+LOG11B+LOG01L
B: LOG01P+LOG10K+LOG14K+LOG11B

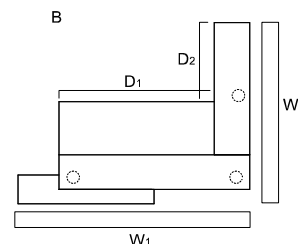
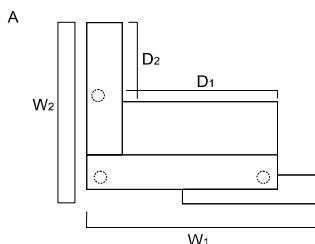

SYMBOL		WYMIARY [mm]					PLN				UWAGI
A	B	W ₁	W ₂	D ₁	D ₂	H					
LOG18LG	LOG18PG	1700	1370	1140	600	1105		99.5	1.187	7	

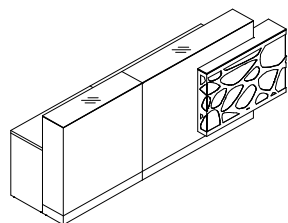

A: LOG10K+NE41+LOG14K+LOG10B+LOG14B+LOG01L
B: LOG01P+LOG14K+NE41+LOG10K+LOG14B+LOG10B

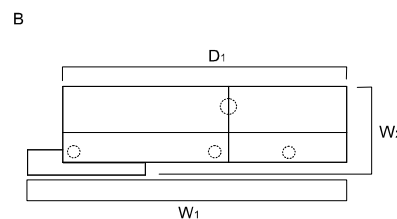
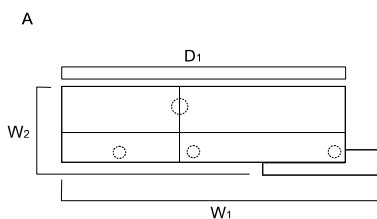

SYMBOL		WYMIARY [mm]					PLN				UWAGI
A	B	W ₁	W ₂	D ₁	D ₂	H					
LOG19LG	LOG19PG	2700	770	2400	-	1105		115.8	1.577	9	

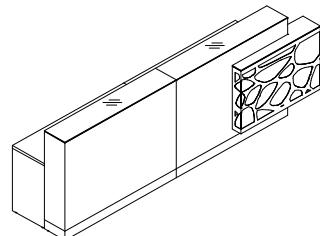

A: 2xLOG14K+NE41+2xLOG14B+LOG01L
B: LOG01P+2xLOG14K+NE41+2xLOG14B

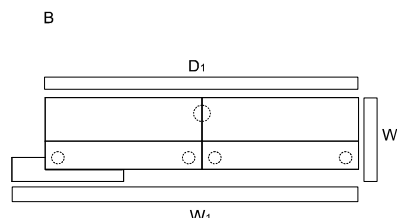
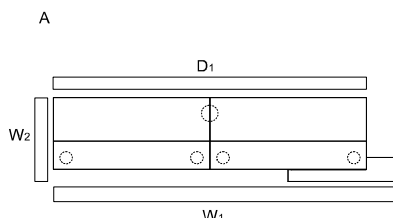

SYMBOL		WYMIARY [mm]					PLN				UWAGI
A	B	W ₁	W ₂	D ₁	D ₂	H					
LOG20LG	LOG20PG	3100	770	2800	-	1105		120.8	1.809	9	

LEGENDA:

- WAGA NETTO

- OBJĘTOŚĆ

- ILOŚĆ PACZEK

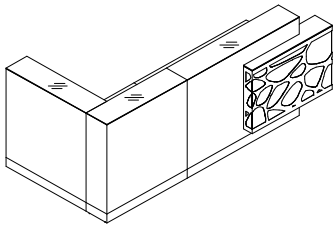
UKŁADY LAD

A

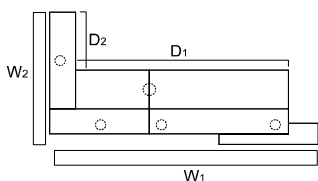

B

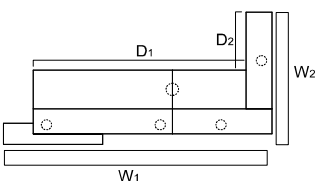

A: 2xLOG10K+LOG14K+LOG10B+LOG14B+NE41+LOG01L+LOG08B
 B: LOG01P+LOG14K+NE41+LOG14B+LOG10B+2xLOG10K+LOG08B

SYMBOL		WYMIARY [mm]					PLN				UWAGI
A	B	W ₁	W ₂	D ₁	D ₂	H		kg	m ³	szt	
LOG21LG	LOG21PG	2700	1370	2140	600	1105		146.8	1.575	10	

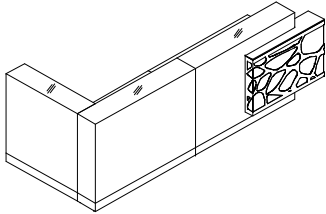

A

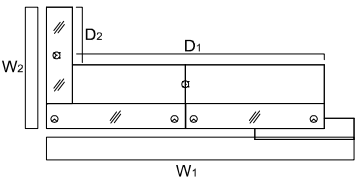

B

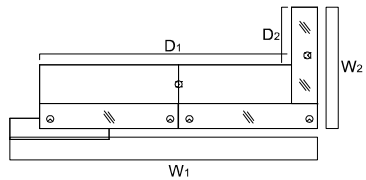

A: LOG10K+2xLOG14K+LOG11B+LOG14B+NE41+LOG01L
 B: LOG01P+2xLOG14K+NE41+LOG14B+LOG11B+LOG10K

SYMBOL		WYMIARY [mm]					PLN				UWAGI
A	B	W ₁	W ₂	D ₁	D ₂	H		kg	m ³	szt	
LOG22LG	LOG22PG	3100	1370	2540	600	1105		155.8	2.018	10	

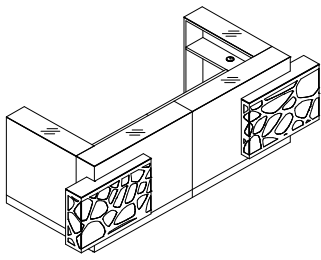

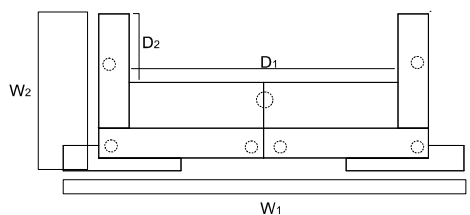

2xLOG10K+2xLOG14K+2xLOG11B+NE41+LOG01L+LOG01P

SYMBOL	WYMIARY [mm]					PLN				UWAGI
	W ₁	W ₂	D ₁	D ₂	H		kg	m ³	szt	
LOG23G	3400	1370	2280	600	1105		200.3	2.390	15	

LEGENDA:

- WAGA NETTO

- OBJĘTOŚĆ

- ILOŚĆ PACZEK

UKŁADY ŁAD

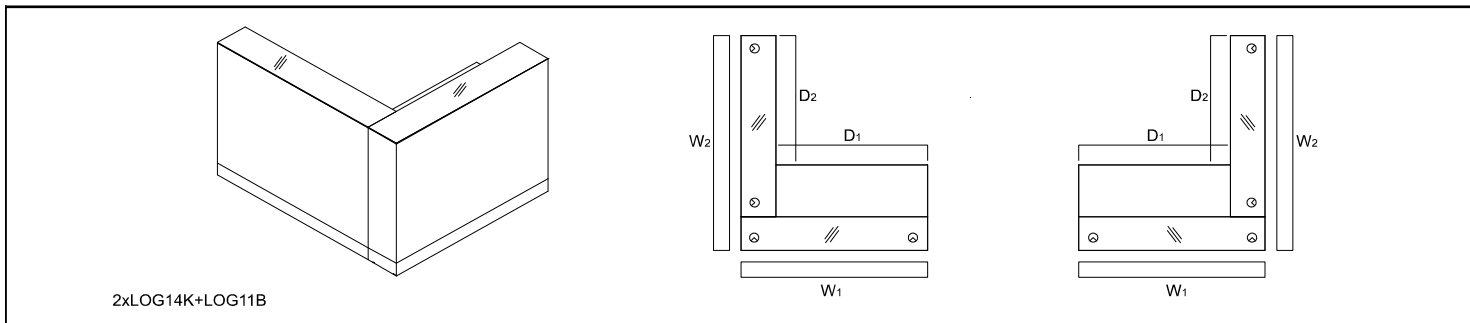

SYMBOL	WYMIARY [mm]					PLN				UWAGI
	W ₁	W ₂	D ₁	D ₂	H		kg	m ³	szt	
LOG15	1400	1660	-	-	1105		95.0	1.138	3	

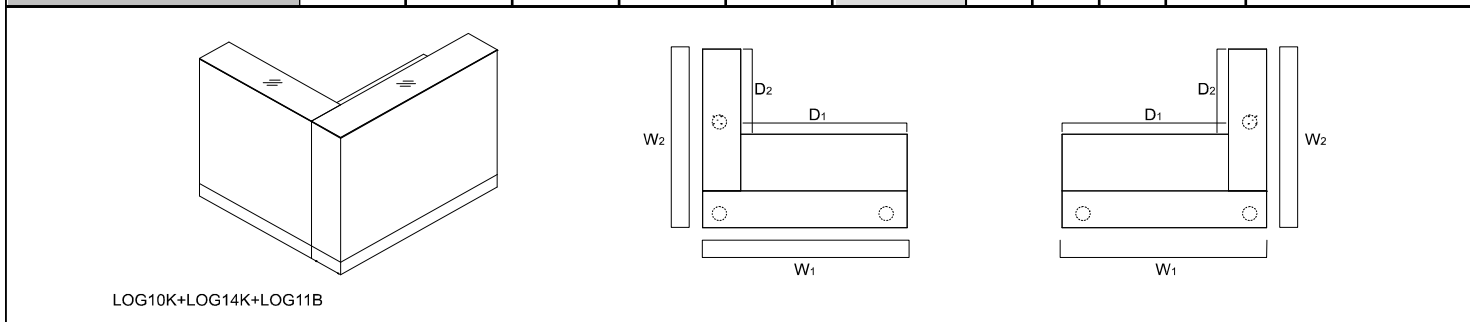



SYMBOL	WYMIARY [mm]					PLN				UWAGI
	W ₁	W ₂	D ₁	D ₂	H		kg	m ³	szt	
LOG17	1400	1260	-	-	1105		90.0	1.024	3	

LEGENDA:





- WAGA NETTO

- OBJĘTOŚĆ

- ILOŚĆ PACZEK

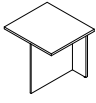
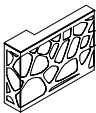
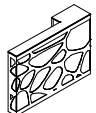
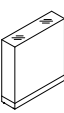
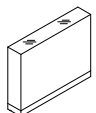
WIDOK I RZUT OBIEKTU	WYMIARY [mm]			SYMBOL	CENA NETTO PLN				UWAGI
	SZEROKOŚĆ	GLĘBOKOŚĆ	WYSOKOŚĆ			kg	m3	szt	

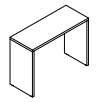
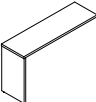
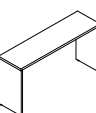
ELEMENTY SKŁADOWE

	700	770	740	LOG07		13.3	0.049	2	
	1000	220	710	LOG01P		9.5	0.163	4	prawa
	1000	220	710	LOG01L		9.5	0.163	4	lewa
	1000	260	1105	LOG10K		35.0	0.286	1	
	1400	260	1105	LOG14K		40.0	0.400	1	
	740	400	28	LOG08B		11.0	0.008	1	
	1000	400	740	LOG10B		15.0	0.296	1	
	1140	400	740	LOG11B		15.0	0.337	1	
	1400	400	740	LOG14B		15.0	0.414	1	
	40	40	712	NE41		1.5	0.017	1	noga okrągła

LEGENDA:

 - WAGA NETTO

 - OBJĘTOŚĆ

 - ILOŚĆ PACZEK